



User's Manual

Vertiv™ Knürr® DCD

Rear door heat exchanger up to 50kW



Date / Datum	Issue / Ausgabe	ECR	Author / Erstellt	Reviewed / Geprüft
15/06/17	01.998.355.0.c	18242	Heiko Ebermann	Tilo Büttner
26/01/18	01.998.355.0.d	18384	Heiko Ebermann	Tilo Büttner
22/11/2018	01.998.355.0e		Claudia Wolf	Heiko Ebermann

Unit code and component location

MODEL NUMBER - PART 1/2										MODEL DETAILS											PART 2/2			
1	2	3	4	5	6	7	8	9	10	11	12	13	14	15	16	17	18	19	20	21	22	23	24	25
D	C	D	3	5																				
D	C	D	5	0																				

1-3 Basic unit Knürr DCD is an air-water exchanger that is integrated into the rear door of a server cabinet. The heat exchanger serves to absorb heat loads from server cabinets of up to 35 and 50kW. Thereby, it can be configured in such a way that no thermal loads are released to the installation area.	4-5 Nominal cooling capacity 35 = 35kW 50 = 50kW (cabinet width 800mm only)	6 Cabinet height A = For rack height of 2000 mm B = For rack height of 2100 mm C = For rack height of 2200 mm	7 Cabinet width 0 = DCD Active Fan Unit (w/o rack) 6 = For rack width of 600 mm (not available for DCD 50) 7 = For rack width of 700 mm (not available for DCD 50) 8 = For rack width of 800 mm	8 Cabinet type 3 = The DCD unit is equipped with adaptor for 3rd party rack 0 = The DCD unit is delivered without cabinet and can be mounted on site on existing DCM cabinet. A = Unit will be shipped from factory installed on a DCM rack. (no DCDactive) B = DCD with DCM cabinet and DCDactive F = DCD Active Fan Unit	9 CW connection - hinge position 0 = DCD Active Fan Unit only 1 = Unit has chilled water connections from the top left side 2 = Unit has chilled water connections from the top right side 3 = Unit has chilled water connections from the bottom left side 4 = Unit has chilled water connections from the bottom right side	10 Cabinet depth 0 = No cabinet E = The Rack depth is 1000 mm F = The Rack depth is 1100 mm G = The Rack depth is 1200 mm	11 Front door 0 = No cabinet C = with Single Sheet Steel Front-Door 83% perforation, hinged right hand side, G = with Double Sheet Steel Front-Door 83% perforation, L = with Single Sheet Steel Front-Door 83% perforation, hinged left hand side, X = Cabinet without front door	12 19" rails front 0 = No cabinet L = Asymmetric with air separation and additional vertical U slots A = Symmetric with air separation and additional vertical U slots B = Symmetric with air separation (for width 600mm only)	13 19" rails rear 0 = No cabinet Y = Asymmetric without air separation (for width 700mm and 800mm) S = Symmetric without air separation (not for width 700mm) A = Symmetric with air separation and additional vertical U slots B = Symmetric with air separation (for width 600mm only) L = Asymmetric with air separation and additional vertical U slots	14 Bottom plate 0 = No cabinet L = Cable entry for cabinets with levelling feet R = Cable entry for cabinets with casters	15 Plinth 0 = No cabinet A = with stationary plinth load rating 10 000 N static height 100 mm (rack height + 100 mm). B = with stationary plinth load rating 10 000 N static height 200 mm (rack height + 200 mm). R = with caster brackets and high load casters 10 000 N mobile, 15 000 N static on levelling feet. F = with levelling feet (0-25 mm), no plinth	16 Color 1 = Visible surface of covers RAL 7035 (light gray) G = Visible surface of covers RAL 7021 (dark gray)	17 Side panels 0 = No cabinet X = Without side panels B = with right + left side panel,	18 Jumpering depth for front 19" rails 0 = No cabinet A = jumpering space 80 mm, useful depth 740 mm, D = jumpering space 123 mm, useful depth 740 mm,	19 DCDactive upgrades 0 = no DCDactive N = Standard DCD Active T = DCD Active with temperature monitoring and display B = DCD Active with A/B transfer switch 230VAC A = DCD Active with A/B transfer switch 230VAC + temperature monitoring and display D = DCD Active with A/B transfer switch 115VAC C = DCD Active with A/B transfer switch 115VAC + temperature monitoring and display	20 Free 0	21 Packaging P = DCD / DCD Active packed in cardboard box lying on pallet (max. 4 units); DCM Rack/DCD/DCD Active S = DCD / DCD Active packed in cardboard box lying on pallet (max. 4 units), wooden crate; DCM	22 SFA A = No SFA X = SFAs included	23-25 Internal counter
--	--	---	--	--	---	--	--	--	--	---	--	--	---	--	---	---------------------	---	--	-------------------------------

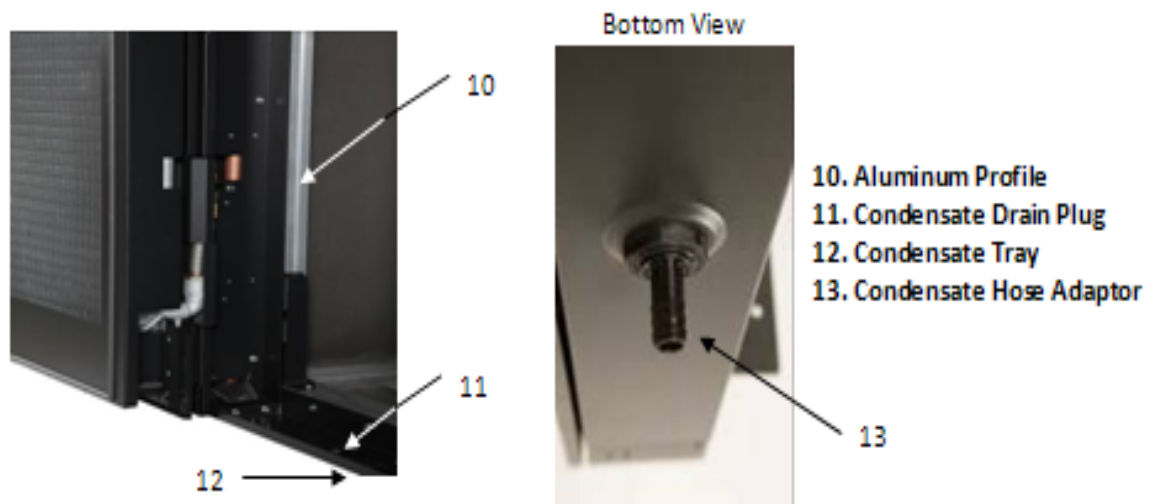
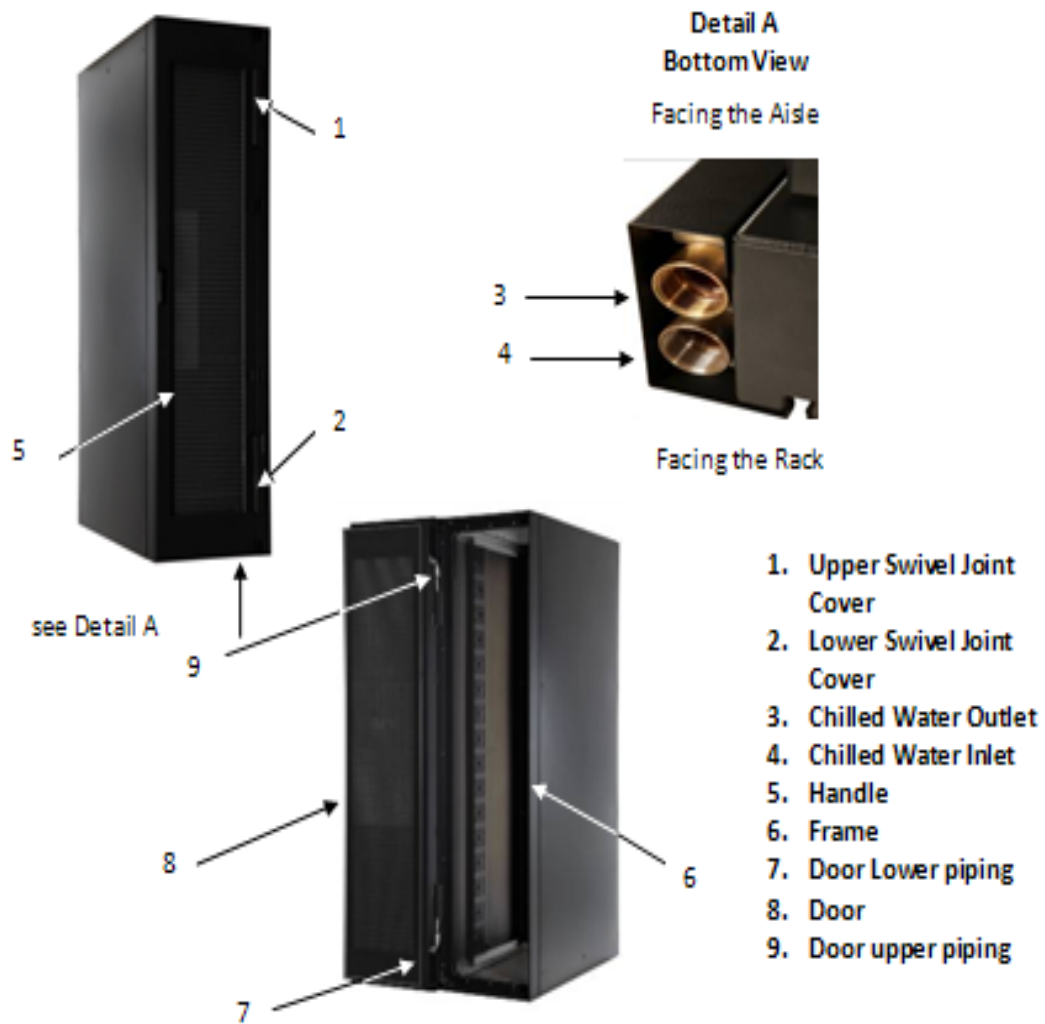

Figure 1 Component location

Contents

Unit code and component location	3
Contents	5
List of figures	6
List of tables	8
0 Abstract	9
1 Safety	10
1.1 Symbols	10
1.2 Safety notice	11
2 Storage and transportation	14
3 Installation and commissioning	15
3.1 Preparations for installation	15
3.2 Piping and connection methods	16
3.3 Assembly procedure and tools required	20
3.3 Chilled water connection	34
3.4 Filling with water	36
3.5 Housing integrity	37
3.6 Application conditions	38
4 Description	40
4.1 General function	40
4.2 Cooling principle	41
4.3 Submittal drawings	42
5 Variants and options	46
5.1 Knürr DCD built in the server rack (Optional)	46
5.2 DCD Module Active	47
5.2.1 Technical Specifications	47
5.2.2 General	48
5.3 Connection set Knürr DCD (optional)	69
5.4 Spacing kit and BSP to NPT adapter (optional)	72
6 Maintenance and repairs	73
7 Disassembly and disposal	74
8 Customer service	74
9 Annexes	75
9.1 Quality Requirements for water used in the Knürr DCD	75
9.2 Checklist for Setting up the Device	77
9.3 Commissioning Protocol	79
9.4 Knürr DCD – performance charts	86
9.5 Unit conversion chart	91

Knürr DCD

User's Manual

List of figures

Figure 1 Component location	4
Figure 2 Ring piping	16
Figure 3 Tichelmann ring piping	16
Figure 4 Non - interlaced piping	17
Figure 5 Floor cut outs below the unit itself	18
Figure 6 Floor cut outs - unit with aluminium frame for 3 rd party racks	19
Figure 7 Unpacking Knürr DCD	22
Figure 8 Unpacking the Knürr DCD (part of the rack)	23
Figure 9 Lifting the frame	24
Figure 10 Marking the position	24
Figure 11 Inserting the spring nuts	25
Figure 12 Diamond nuts	25
Figure 13 Hose piece adaptor	26
Figure 14 Position of the sealing foam	27
Figure 15 Tightening the screws	27
Figure 16 Installing the door	28
Figure 17 Flexible piping	29
Figure 18 Inserting sealing rings	29
Figure 19 Piping connection	30
Figure 20 Tightening the union nuts	30
Figure 21 Hinge covers orientation and position	31
Figure 22 Outmost swivel joint covers connection points	32
Figure 23 Attaching the swivel joint covers	32
Figure 24 Inside swivel joint covers	33
Figure 25 Attaching the grounding wire	33
Figure 26 Pipe labels position	35
Figure 27 Chilled water connection	36
Figure 28 Bleeding point	37
Figure 29 Top view of the rack equipped with Knürr DCD	40
Figure 30 Side view of the rack equipped with Knürr DCD	41
Figure 31 Submittal drawings – Knürr DCD	43
Figure 32 Aluminium frame submittal drawing	44
Figure 33 Server rack with the Knürr DCD	46
Figure 34 Disassembly of the hood cover	51
Figure 35 PE connector pin	51
Figure 36 Upper and lower mounts of the DCD35 Active for attaching it to the DCD	52

Knürr DCD

User's Manual

Figure 37 Upper and lower mounts of the DCD50 Active for attaching it to the DCD (H2000, H2200)	53
Figure 38 Connections and points of wire fixation of the DCD35 Active (H2000)	54
Figure 39 Connections and points of wire fixation of the DCD50 Active (H2000)	55
Figure 40 Points of wire fixation of the DCD35/DCD50 Active (H2200)	55
Figure 41 central control, alarm connections	57
Figure 42 Installation of alarm cable, red - top side, pink - underside of the basic housing, lead through cable grommet	58
Figure 43 Main screen	59
Figure 44 Detail menu Fans	60
Figure 45 Detail menu of Exhaust Air Sensors	60
Figure 46 Detail menu of Cabinet Sensors	61
Figure 47 Menu Settings	62
Figure 48 Sub-menu Temperature Sensors	62
Figure 49 Sub-menu Choose Units	63
Figure 50 Sub-menu Server Teach Cabinet Sensors	64
Figure 51 Sub-menu Regulation	64
Figure 52 Setup menu	65
Figure 53 – Sub-menu Teach Exhaust Air Sensors in the DCD35/50	65
Figure 54 Sub-menu Pressure Levels	66
Figure 55 Connection set	70
Figure 56 Connection set - detail	71
Figure 57 Spacing kit and adapter	72
Figure 58 Performance chart Knürr DCD35 - 1	86
Figure 59 Performance chart Knürr DCD35 - 2	87
Figure 60 Performance chart Knürr DCD35 - 3	87
Figure 61 Performance chart Knürr DCD50 - 1	88
Figure 62 Performance chart Knürr DCD50 - 2	88
Figure 63 Performance chart Knürr DCD50 - 3	89
Figure 64 Cooling air pressure drop Knürr DCD35	89
Figure 65 Cooling air pressure drop Knürr DCD50	90
Figure 66 Chilled water pressure drop DCD35	90
Figure 67 Chilled water pressure drop DCD50	91

List of tables

Table 1 Unit weight..... 14

Table 2 List of tools required 21

Table 3 Packaging list 21

Table 4 Pipe positioning 35

Table 5 Operation conditions 39

Table 6 Unit dimensions 42

Table 7 Aluminium frame dimensions 45

Table 8 Technical specifications 45

Table 9 Spacing kit and adapter..... 72

Table 10 Water quality requirements 75

Table 11 Hydrological requirements..... 75

Table 12 Set up checklist 77

Knürr DCD

User's Manual









0 Abstract

Knürr DCD is an air - water heat exchanger that is integrated into the rear door of a server rack. The heat exchanger is suitable for absorbing heat loads from server racks of up to 50 kW. It can be configured in such way that no heat is released to the installation area.





Cooling effect occurs when the server exhaust air passes through the heat exchanger in the rear section of the server rack. The cooling air is moved through the heat exchanger only by the server fans. Knürr DCD thereby supports the cold room concept in which the warm exhaust air from servers always led to a cooling device where its temperature is reduced to the temperature level of the server supply air. The supply air for chilled water system flows freely through the installation area.

1 Safety

1.1 Symbols

	<p>Attention! Danger spot! Safety notice!</p>
	<p>Caution! Hot surface.</p>
	<p>Attention! Refers to possible damage to the device.</p>
	<p>Note! Marks possible hazards for the environment.</p>
	<p>Important note, information.</p>
	<p>ATTENTION Notes marked ATTENTION make you aware of severe hazards of accidents or injuries.</p>
	<p>CAUTION Notes headlined CAUTION make you aware of potential damage that may be caused due to improper handling.</p>
	<p>NOTE This is a practical note to make you aware of important information on the functionality of the device.</p>

1.2 Safety notice

	<p>Our engineers can give you comprehensive advice in assembling the Knürr DCD. Extensive material, functional and quality testing guaranty high benefit and a long lifecycle. Nonetheless, such devices may cause hazards if improperly handled by untrained personnel and if used for purposes they are not intended for.</p>
	<p>Carefully read this assembly and operational manual prior to assembling and commissioning the Knürr DCD.</p>
	<p>Hazard by works on the device carried out by non-experts. Maintenance and cleaning operations are only permitted to be performed by trained personnel. In order to keep the device in operationally safe condition and to grant its long lifecycle, maintenance and cleaning intervals must be fulfilled by all means.</p>
	<p>Operate the Knürr DCD only in accordance with its specified purpose, within its limits of capacity and approved operating means.</p>
	<p>When performing any works on and with the device, please mind:</p> <ul style="list-style-type: none"> • Any respectively applicable regulations (e.g. VDE regulations or other nationally applicable guidelines) • Any applicable accident prevention regulations (BGV) • Any respective provisions • Any applicable environment protection acts <p>Operate the device only in its proper condition. In the event of functional disturbances or deficiencies, the device must immediately be taken out of operation and the operator's responsible person must be informed of its state. The device must only be taken into operation again after the flawless function of the device has been restored.</p>



Caution! Hot surface! Defect fans, power supply units or control boards may have run hot. Allow them to cool down before commencing any operations.



ATTENTION

Please, carefully read these Operating Instructions prior to taking this unit into operation.

Apply this unit to the intended use only as described in these Operating Instructions.

This unit must be maintained by a trained electrician. Local safety regulations shall be complied with.

Any works on the electrical unit must be performed only when disconnected from power. The unit shall be disconnected from power by switching OFF all poles, and it must be safeguarded against being switched ON unintentionally. It must be connected to marked sources of power supply only.

If the unit or parts of the unit are damaged, it must unconditionally be separated from power supply (switch OFF the mains fuse)!

The unit or parts thereof must never be exposed to rain or water. Fluids or other foreign matter must be prevented from ever entering the device through the openings in its housing.

The unit must not be used, cleaned or maintained by children or persons of reduced physical, sensory or mental capabilities or by those lacking experience or knowledge.

No modification of or tampering with these controls, nor any opening of the lid are permissible and release the manufacturer from any warranty and liability.

2 Storage and transportation

- Keep the device in its original packaging, protected from the weather and in dry conditions
- Protect the working parts from dirt (e.g. sand, rain, dust, etc.)
- Store at temperatures between **-30 °C and +50 °C** (-22 °F and +122 °F)
- Chilled water circuit must be empty during storage (risk of frost damage)
- After long period of storage (1 year +) inspect functionality of water-bearing hinges
- Remove all the packaging before commencing operation of the device
- Chilled water connections are not to be used as a transport handles
- When transporting always make sure the device is properly fastened and secured against slipping

Table 1 Unit weight

Width	Dry net weight +/- 5% kg (lb)
	DCD (without rack)
600 mm	~ 95 kg / ~ 210 lb for DCD35 ~ 105 kg / ~ 230 lb for DCD50
700 mm	
800 mm	
Land freight packaging	+40 kg / +88 lb
Seaworthy packaging	+125 kg / +276 lb

3 Installation and commissioning

3.1 Preparations for installation



Before installing the device it is crucial You check each of the following points. These checks will ensure safe and trouble free operation of Knürr DCD. Perform these tests with great care.

- **Check the device for shipping damage**

Packaging may not appear to have been damaged; however, it is necessary to inspect the device before proceeding to installation. Ignoring this advice may at worst lead to a functional failure. *(When returning the device because of the shipping damage – If the device is not being sent in its original, packaging please make sure the distance between the device and the new packaging is at least 30 mm ~ 1.18 in)*

- **Qualified installation**

Please find the checklist enclosed in the annex to help with installation. Commissioning can also be done by specialized company. In this case please find the commissioning protocol enclosed in the annex.

- **Room Preparation**

The room should be well-insulated and must have a sealed vapor barrier. The vapor barrier in the ceiling and walls can be a polyethylene film. Paint on concrete walls and floors should contain either rubber or plastic. The vapor barrier is the single most important requirement for maintaining environmental control in the conditioned space.

Knürr DCD

User's Manual

3.2 Piping and connection methods

If possible when using a chilled water distribution unit such as the Knürr CoolTrans or the Liebert XDPW, connect the Knürr DCD in an “ring” configuration (see Figure 2) or Tichelmann ring (Figure 3) In this system the pressure drop for each of the units is approximately the same which results in even cooling performance.

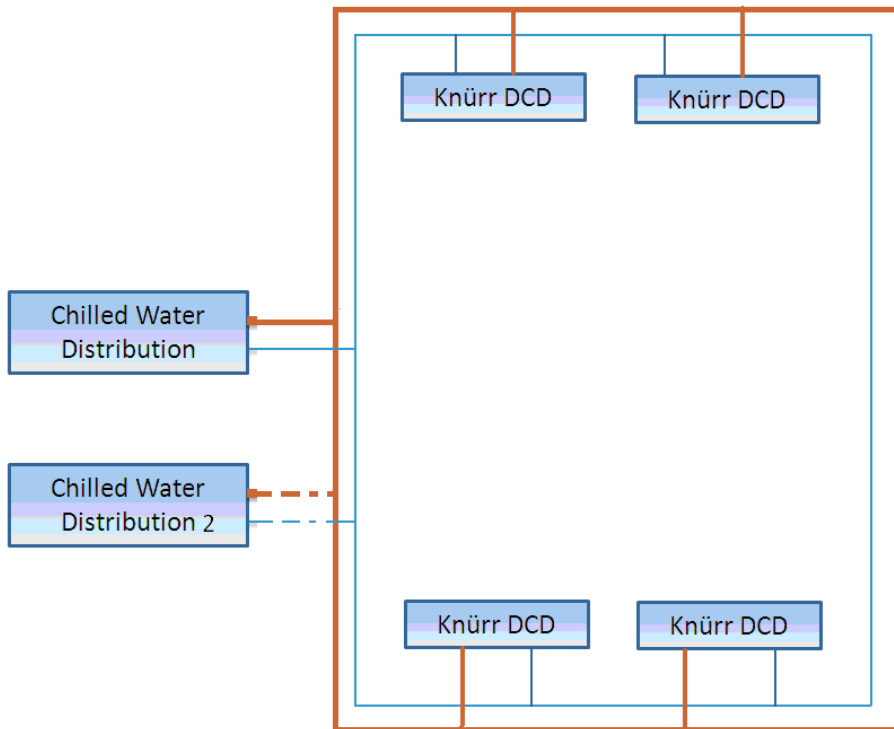

Figure 2 Ring piping

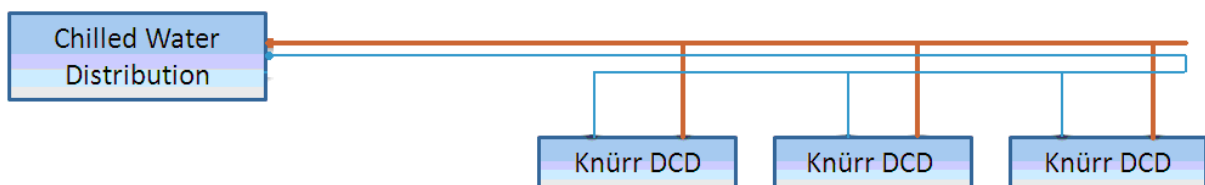

Figure 3 Tichelmann ring piping

Knürr DCD

User's Manual

However, if it is not possible, connect the Knürr DCD units in a non-interlaced configuration as seen in Figure 4.

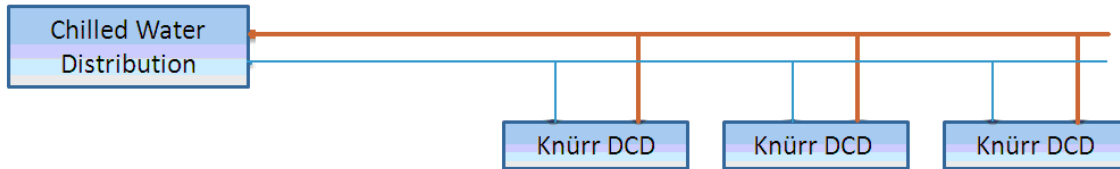

Figure 4 Non - interlaced piping

It is recommended to add a connecting set. It consists of a ball valve and a commissioning valve to each unit (supply and return pipe). It allows the unit to be disconnected from the system for repairs and maintenance without taking the whole system down.

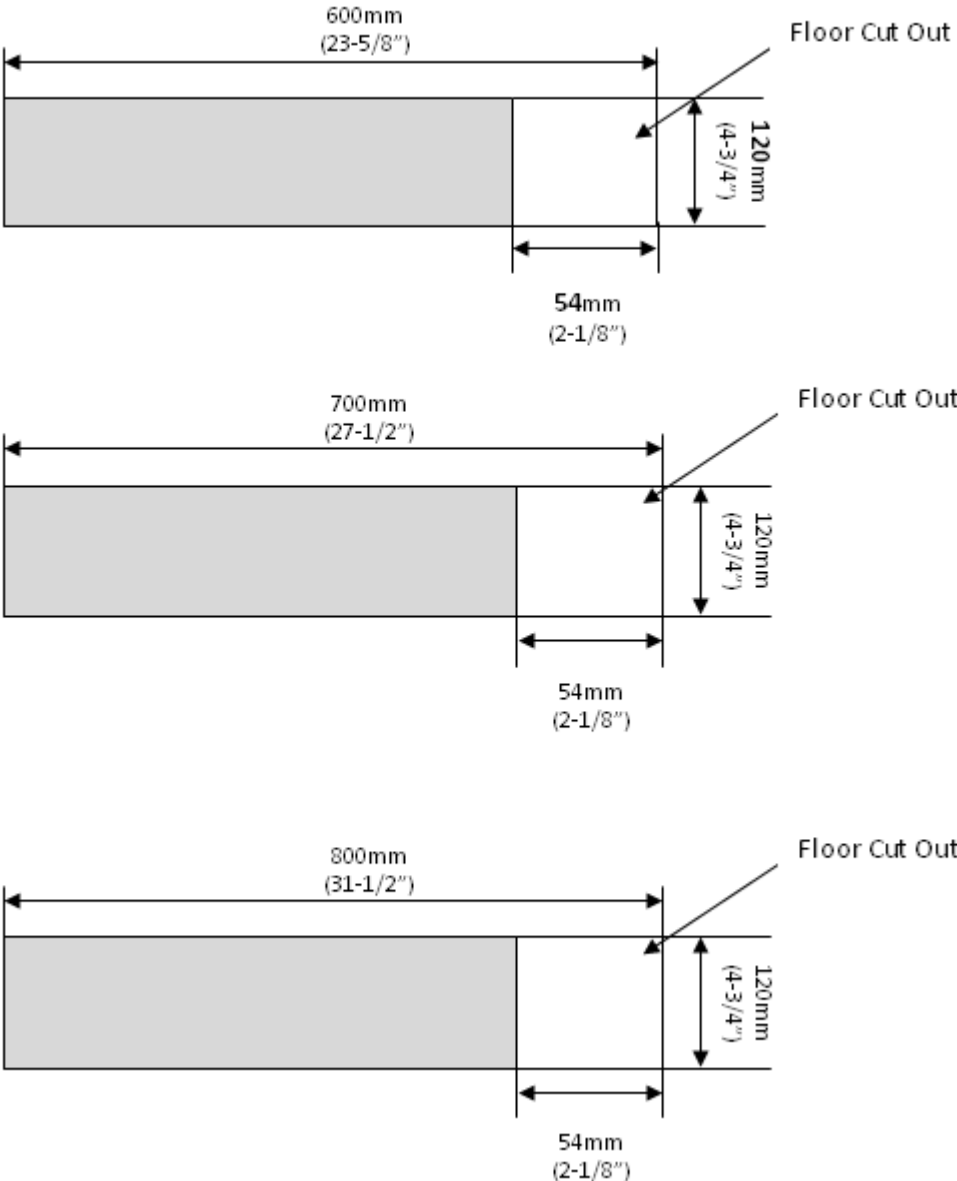

Figure 5 Floor cut outs below the unit itself

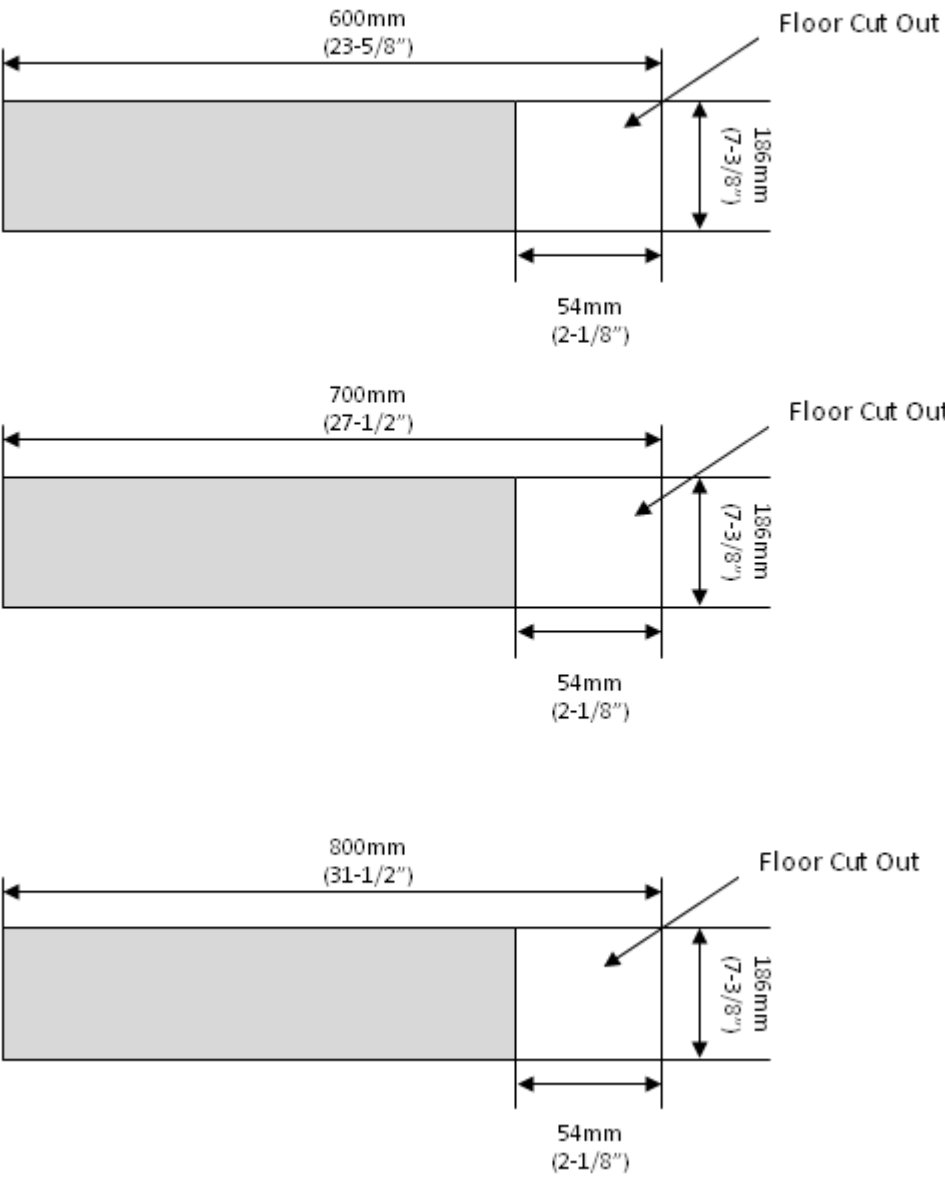





Figure 6 Floor cut outs - unit with aluminium frame for 3rd party racks

3.3 Assembly procedure and tools required

	<p>Assembly of the Knürr DCD must be carried out in vertical position of the device. Please use a level to make sure this requirement is met when commencing the installation.</p> <p>Knürr DCD and the rack must be vertically aligned to provide proper functionality. Strict separation between the hot and cold air within the cabinet must exist.</p>
	<p>To ensure sufficient air circulation please make sure there are no obstructions (e.g. packaging materials, tools etc.) left in...</p> <ul style="list-style-type: none"> • Grids • Heat exchanger • Air intake • Air outlet

This guideline only applies if you have bought Knürr DCD as a separate product (not being part of a rack already). If you bought the Knürr DCD as a part of the rack it would come already assembled. (In this case please proceed (after unpacking – Figure 7) to attaching the hose adaptor piece from beneath (Figure 12). The procedure described is valid for Knürr cabinet (DCM) only.

	<p>Installation and commissioning of the Knürr DCD must be performed only by qualified personnel. All actions must be in accordance with regulations and instructions of the manufacturer.</p>
	<p>Warning! Protective equipment (e.g. boots) must be worn during installation and maintenance of this device. Please check your local regulations on using safety equipment before commencing any operations.</p> <p>This procedure also requires at least 2 people to complete. The Knürr DCD35 weights 95 kg (approx. 210 pounds), Knürr DCD50 weights 105 kg, (approx. 230 pounds).</p>

Socket hexagonal screw driver - **8 mm** (5/16") (for M5 screws)

Open – jaw wrench **41 mm** (1-5/8")

Open – jaw wrench **36 mm** (1-7/16")

Phillips screw driver PH3

Utility knife

Forklift, pallet jack (or similar device)



Table 2 List of tools required

Quantity	Component description	
1	ST mounting bracket for DCM	
1	ST mounting bracket for DCM	
1	ST cover swivel-joint fixed component	individual components
1	ST cover swivel-joint fixed component	
1	ST cover swivel-joint door component	
1	ST cover swivel-joint door component	
1	ST foam UL94-HF1 20mmx32mm	
1	ST Condensate Drain-Set	
1	ST Wire - Grounding 250/6 RA5xRA5	bag nr. 1
1	ST EARTH WIRE 200/6 RA5xFH6,3pl	
7	ST M5 TENSILOCK NUT	
6	ST M5 MOUNTING NUT-MIR.EXTRUSION	
8	ST washer M5	
30	ST Star Screw M5x10	bag nr. 2
16	ST Spring Nut M5 broad	bag nr. 3
8	ST DIN965 M6x16	bag nr. 4

Table 3 Packaging list

To unpack Knürr DCD (shipped separately) follow the instructions shown in Figure 7.

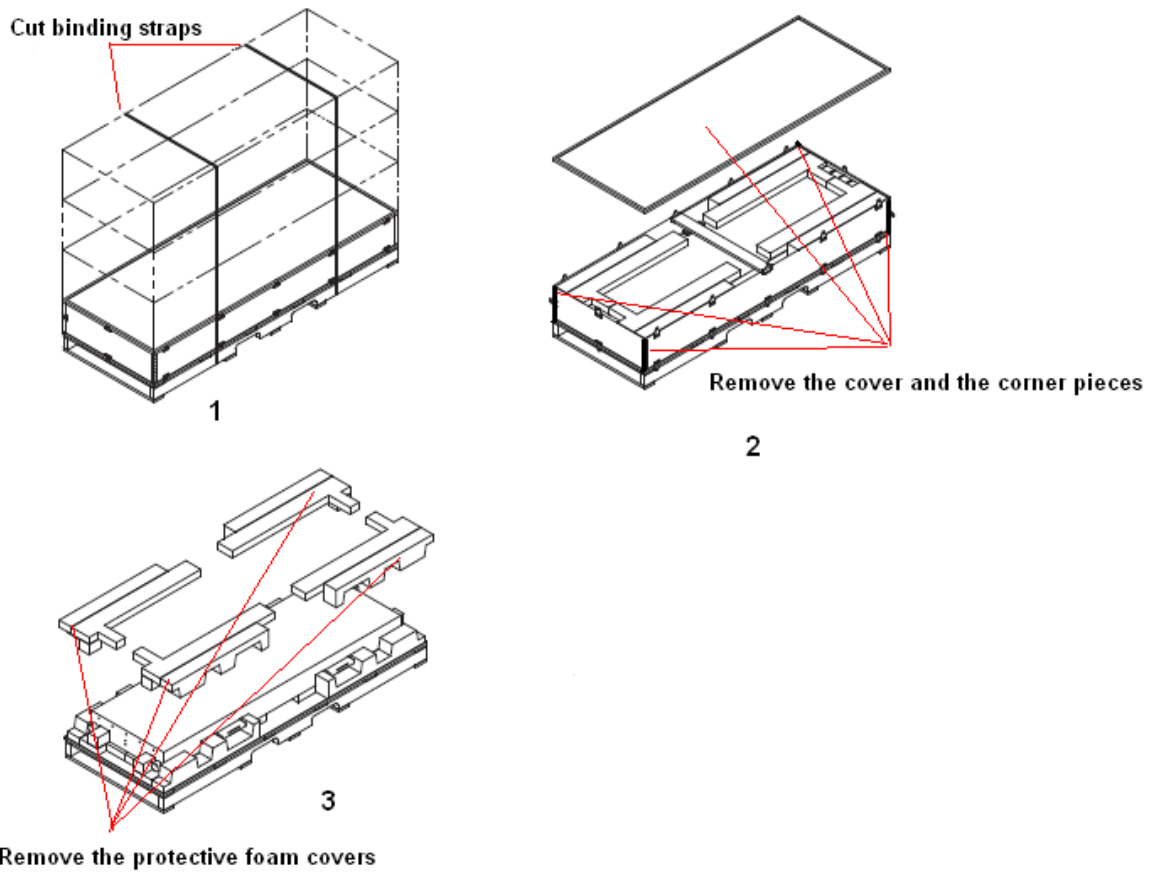

Figure 7 Unpacking Knürr DCD

To unpack the Knürr DCD assembled to a DCM cabinet follow instructions shown in Figure 7.

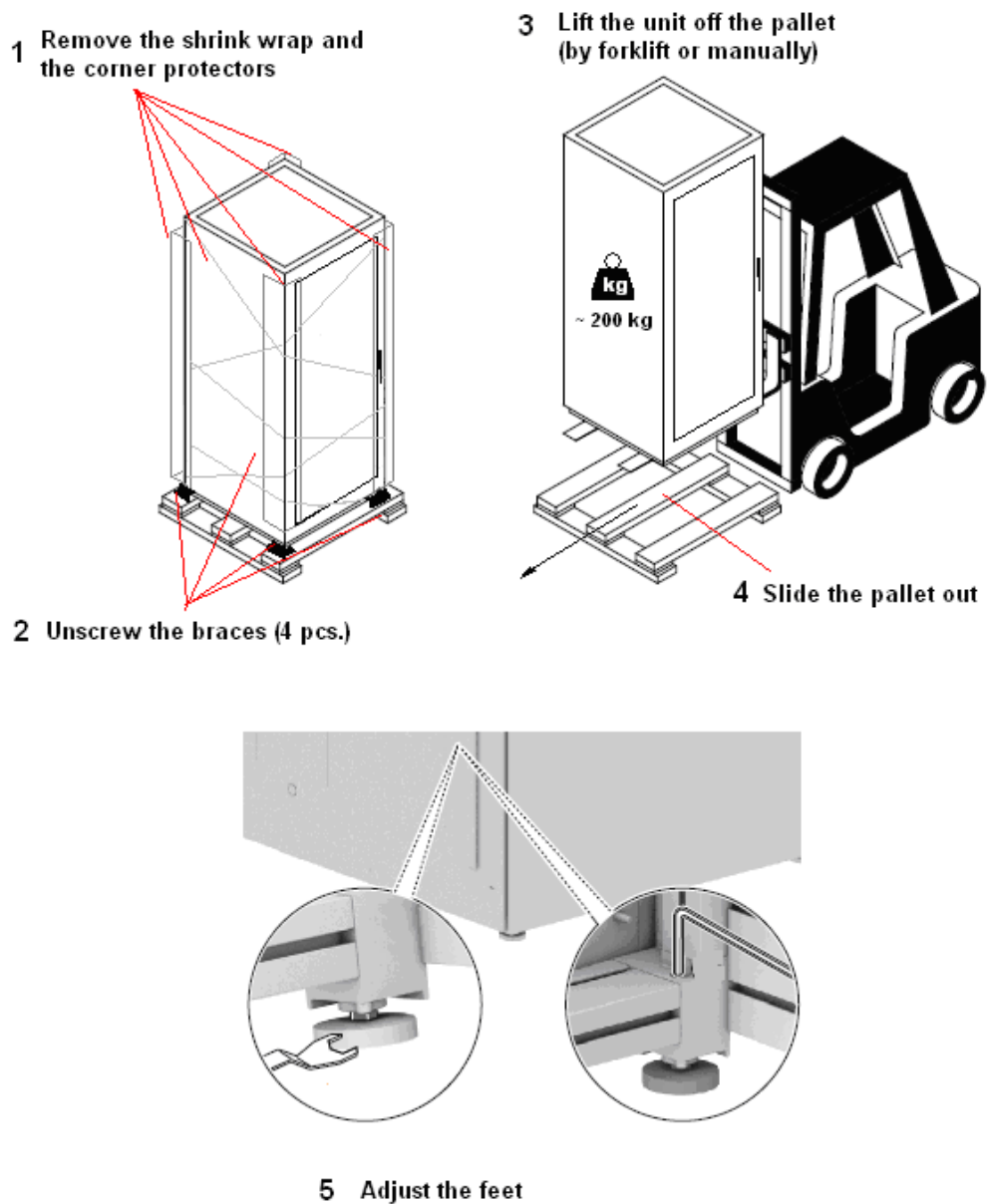

Figure 8 Unpacking the Knürr DCD (part of the rack)

- 1 After removing the packaging, first lift the Knürr DCD frame off the pallet (Figure 8).
At this point the door and the frame are not fixed together yet.



Figure 9 Lifting the frame

- 2 Then align the frame of the Knürr DCD to server rack properly. Mark the positions of the frame holes (there are 16 holes) on the aluminum profile of the server rack and put the frame aside again.

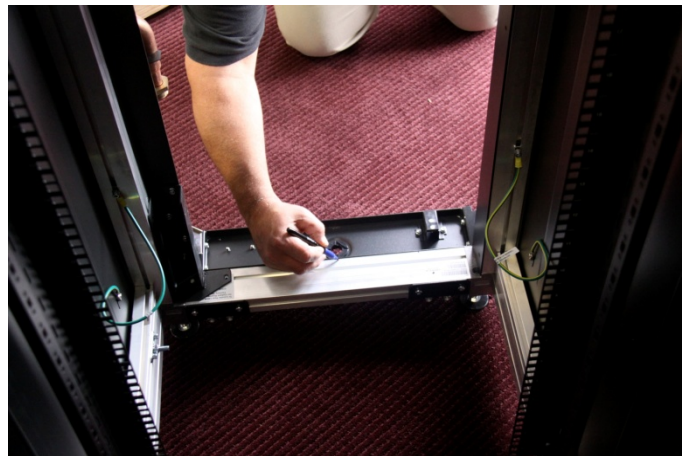

Figure 10 Marking the position

- 3 After that, insert the spring nuts into the groove of the rack aluminum profile in to previously marked position (Figure 10).

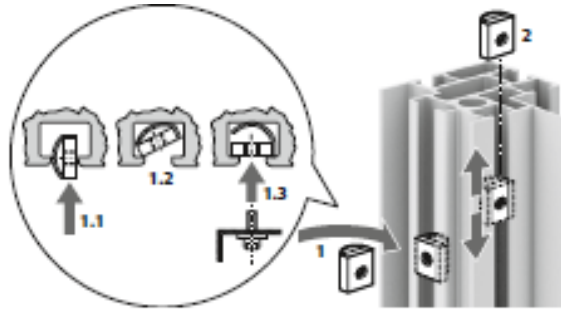

Figure 11 Inserting the spring nuts

- 4 Insert 3 diamond nuts into the groove of each horizontal member of the rack aluminum profile in the previously marked position (Figure 11).

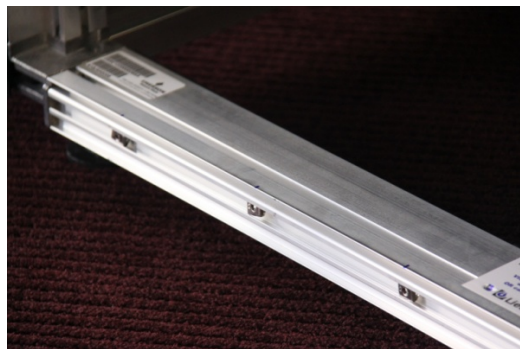

Figure 12 Diamond nuts

- 5 Before proceeding to the next step, connect the hose adaptor piece (5/8 ") into the condensate tray (remove the white plastic plug first) (Figure 12).



Figure 13 Hose piece adaptor

- 6 In the next step place the adhesive strip of foam (included) on the rack's aluminum profile (hinge side) in such way that when the Knürr DCD frame is in the position the foam strip will seal the gap between rack and the Knürr DCD frame (It might be necessary to trim the foam strip with utility knife) (Figure 13).



Figure 14 Position of the sealing foam

- 7 Now you can start attaching the frame of Knürr DCD to the rack using the socket screw driver (Figure 14). Tighten the screws all around the perimeter of the frame, first lightly and then to **3 Nm** (2 pound foot). This is the only way to prevent the frame from twisting and to ensure the parts fit properly.



Figure 15 Tightening the screws

Make sure there is no twist in the frame before proceeding. The next step in installation is to attach the heat exchanger door to the frame.



Attention! Risk of injury! The heat exchanger door is very heavy (**95 kg**, approx 210 pounds for DCD35 / **105 kg**, approx 230 pounds). At least 2 people are required for manipulation with the door.

- 8 Carefully align the door to the frame and insert the door into the frame (Figure 15).



Figure 16 Installing the door

- 9 Hinges are already attached to the door. Fasten them to the frame of the Knürr DCD using the Phillips screw driver. Then check if the door moves freely all the way. If you notice any irregularities or roughness in the movement of the door, check for obstructions or loosen the screws of the hinges and tighten them again. (The rough movement might have occurred because of the twist in the hinges).
- 10 Pull the flexible piping slightly to elongate. This allows the piping enough length to connect the union nuts.



Figure 17 Flexible piping

- 11 Before connecting the heat exchanger (in the door) with the pipe work in the frame of the Knürr DCD, put sealing rings in this connection (Figure 17). Use two wrenches when tightening the union nuts to reduce the stress on the pipes (Figure 18). Torque value for this connection is **85 Nm** (64 foot/pound).



Figure 18 Inserting sealing rings



Figure 19 Piping connection



Figure 20 Tightening the union nuts

- 12 Check again if the door is moving freely at this point. If so you can attach the swivel joint covers.
- 13 The two-outmost swivel joint covers are to be attached to the hinge side of the door. The two inside swivel joint covers are to be attached to the hinge side of the frame (Figure 21). Use hexagonal screw driver to fasten the screws. Correct orientation of the hinge covers is indicated by slotted holes (See picture).

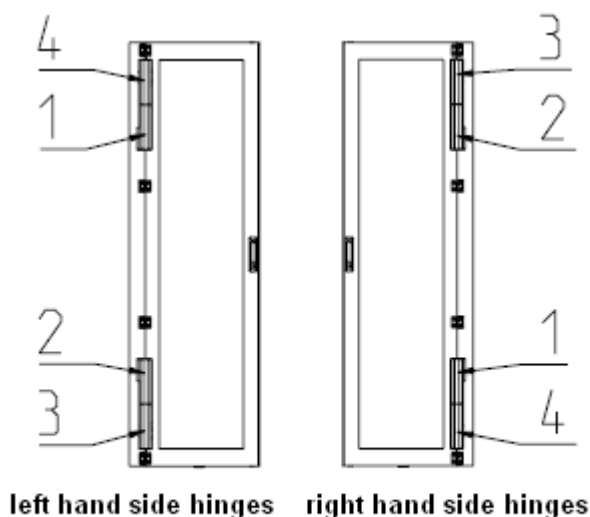
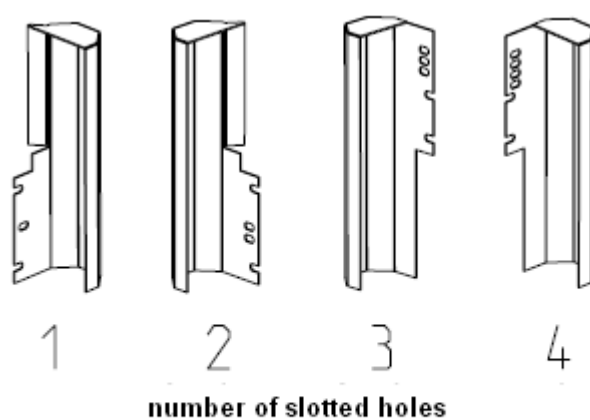

Figure 21 Hinge covers orientation and position



Top Swivel Joint



Bottom Swivel Joint

Figure 22 Outmost swivel joint covers connection points



Figure 23 Attaching the swivel joint covers

- 14** Locate the inside swivel joint cover connection points. The two inside swivel joint covers are to be attached to the hinge side of the frame. Correct orientation of the hinge covers is indicated by a sticker on the covers themselves. Use hexagonal screw driver to fasten the screws (Figure 22)

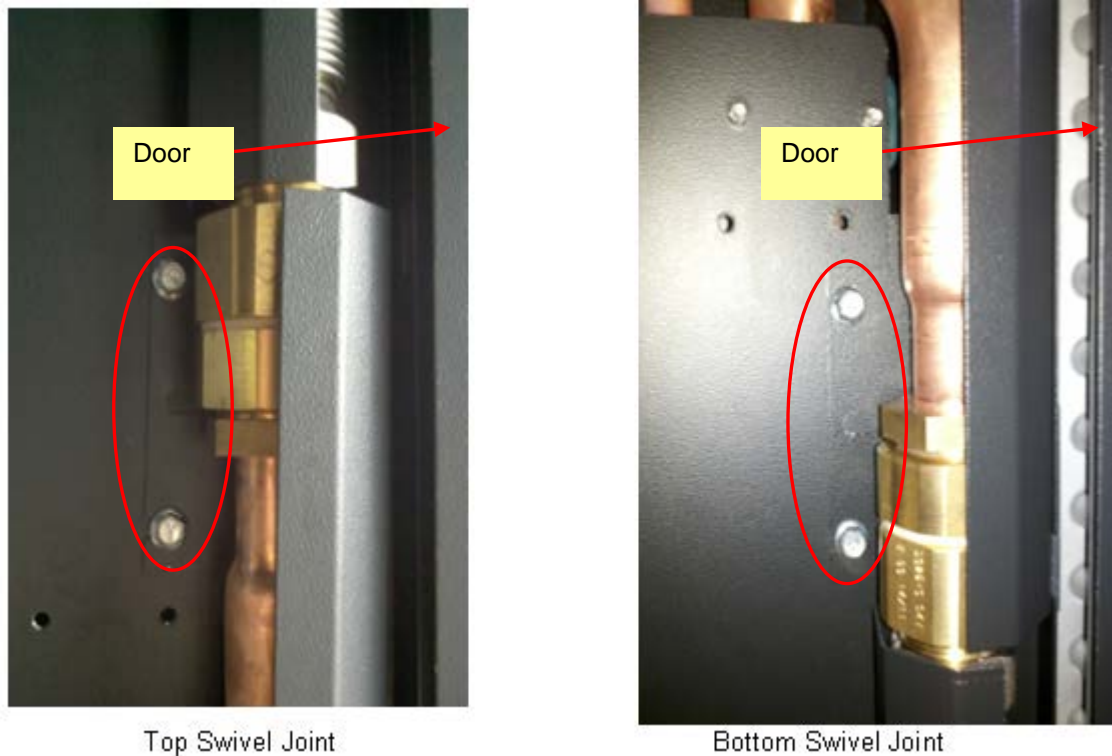

Figure 24 Inside swivel joint covers

- 15** In the last step connect the grounding wire of the door to the frame of the Knürr DCD (Figure 24).



Figure 25 Attaching the grounding wire

Check if this connection is alright (e.g. by using “diode” or continuity test on a millimeter).

- 16** Check functionality of the door lock. Knürr DCD is equipped with DIRAK 1333 lock. It is a half cylinder lock. Keys are provided.

3.3 Chilled water connection

	<p>Check the chilled water system for leaks visually before commissioning. Please check the chilled water pipe connection to the heat exchanger regularly. Tighten this connection if necessary.</p> <p>When setting up the heat exchanger for the first time please inspect the mechanical condition of the chilled water supply and connection thoroughly.</p>
--	--

(Note: Using the optional connection set (chapter 5.2) improves the ventilation and enables chilled water flow monitoring and regulation)

	<p>There is a risk of frost damage to the device during longer stops (e.g. storing etc.) Make sure the heat exchanger and the supply pipes are free of any water (use compressed air if necessary) and remove all the vents and the screws before storing.</p>
---	--

	<p>The coil and piping can be damaged due to thermal expansion of the cooling fluid with no means of expansion (e.g. closing the ball valves on both the supply and the return pipes). Always allow for thermal expansion either by leaving at least one of the valves open or by opening the bleeding valve on the door.</p>
---	---

Supply and return pipes are marked by label on the unit itself. Torque value for this connection is **85 Nm (64 foot/pound)**.



Figure 26 Pipe labels position

Hinge side	Chilled water connection	Supply connection*	Return connection*
left	top	B	A
left	bottom	A	B
right	top	A	B
right	bottom	B	A

Table 4 Pipe positioning



Figure 27 Chilled water connection

	<p>For water supply from the bottom left or top right of the position, the supply water connection is the outward pipe. The return water connection is then the position towards the rack.</p> <p>With water connection from top-left or bottom right, the water supply connection is the pipe towards the rack. The return pipe then has the position toward the outside.</p>
---	--

3.4 Filling with water

If using a chilled water distribution unit such as the Liebert XDPW, refer to its user manual for instructions on filling the Knürr DCD and starting the system. **Heat exchanger fluid volume is approximately 12 liters (3.17 US Gal) for DCD35 and 15 liters (3.96 US Gal) for DCD50.**

Bleeding the air off the system

1. Find the bleeding valve. This valve is located on the upper door piping (see Figure 27).
2. Manually depress the pin to open the valve.
3. Keep the air bleed valve open until the water coming out has no bubbles.

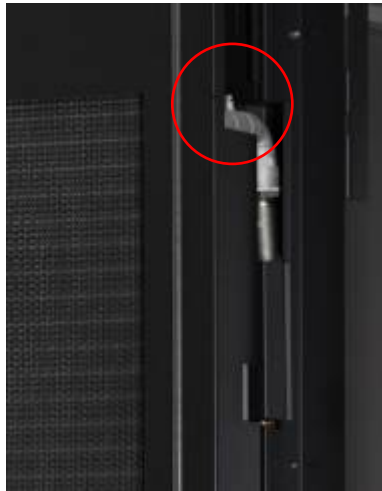

Figure 28 Bleeding point

3.5 Housing integrity

To provide optimal cooling function following requirements must be met

- Strict separation between the hot and cold air must exist within the rack
- All the inlets (cable lines, piping etc) must be sealed to prevent any leakages

3.6 Application conditions



	<p>Appropriate use</p> <p>The device is a rear door heat exchanger for a server cabinet with integrated chilled water piping. The server fans themselves remove the heat from the racks to protect the temperature sensitive components in the rack. The waste heat from inside of the rack is transferred via the chilled water circuit to the outside and passed to the on-site chilled water system.</p>
	<p>For reliable function of the Knürr DCD, chilled water must be available in an appropriate amount, at the appropriate temperature and pressure. The water quality must be in accordance with VGB-R 455 P. (see Annex)</p>

Table 5 Operation conditions

Operating ambient temperature	10 °C ÷ 35°C (<i>other temperatures on request</i>) 50 °F – 95 °F
Maximum absolute air humidity on site	8 g · kg ⁻¹
Chilled water temperature intake	12 °C , 53.6 °F (<i>other temperatures on request</i>)
Chilled water temperature outlet	18 °C , 64.4 °F (<i>other temperatures on request</i>)
Water temperature difference	6 K , 10.8 °F
Use of antifreeze	Not recommended (<i>on request</i>)
Chilled water connection	Rack – rear side (<i>top or bottom connection</i>) 1" female threaded (28xR1 EN10226-1)
Condensate tray drain connection	Rack – rear side
Maximum operating pressure	10 bar (145 psi)



The cold water supply temperature should be higher than the dew point temperature of the installation space. Knürr DCD is designed only for sensible cooling; dehumidification of the room by means of Knürr DCD should be avoided. The built-in condensate tray with condensate drain is designed only for a short-term condensation.

4 Description

4.1 General function

The design of Knürr DCD allows installation in the back of a server cabinet. Heat produced by internal components (e.g. servers etc.), is reliably removed by the door with built-in chilled water system. The cooling system is completely safe so that no water get into the server area. The cooling system consists of a high efficiency air - water heat exchanger. By operating as a rear door heat exchanger with an appropriate design (see Appendix) no heat (thermal load) in the surrounding area is given.



Attention! The cooling with Knürr DCD works only if a strict air separation exists between server cold air intake and server warm air outlet. Unused rack spaces must be sealed with empty plates.

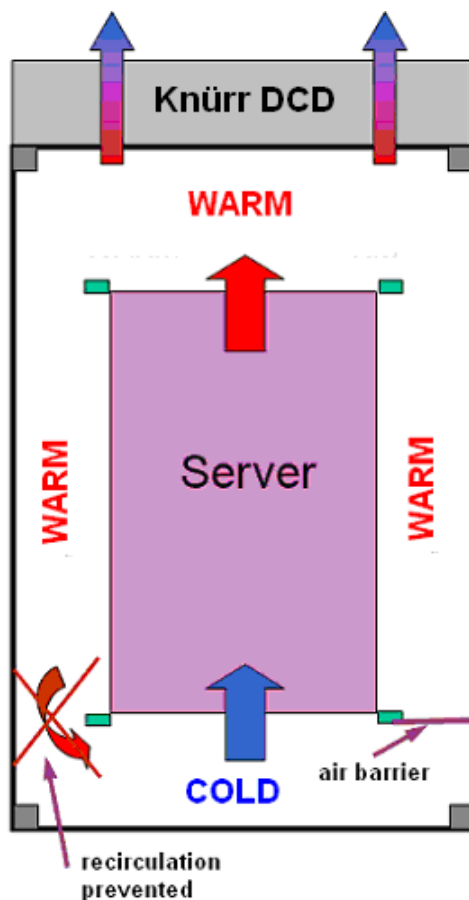

Figure 29 Top view of the rack equipped with Knürr DCD

4.2 Cooling principle

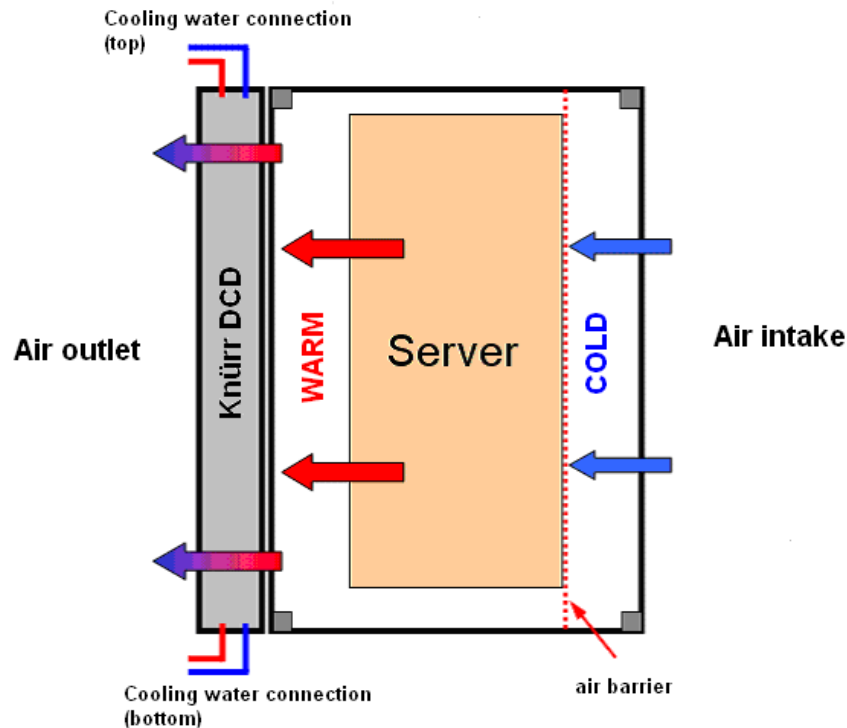

Figure 30 Side view of the rack equipped with Knürr DCD

Air heated by the server (e.g. **40 °C**, 104 °F), is forced through the special air – water heat exchanger. In the heat exchanger the air is cooled down to e.g. **20 °C – 25 °C** (68 °F – 77 °F). The server fans force the cooling air through the heat exchanger of Knürr DCD. The “pressure drop - flow rate” dependency curve is shown in the Appendix (9.4).

	<p>Prior to using Knürr DCD the system and the servers must be checked whether they match hydraulically. In particular, the server fans must be able to generate sufficient pressure to drive the air through the Knürr DCD.</p>
--	--

The chilled water is provided by chilled water onsite distribution.

	<p>In case of chilled water supply system failure the cooling is provided either by adjacent Knürr DCDs and / or the installation room cooling system. In this case the server waste heat is released into the installation room.</p>
--	---

4.3 Submittal drawings

Table 6 Unit dimensions

	2000 mm (78-3/4")			2200 mm (85-3/4")		
600 mm (23-5/8")	B=1954mm	C=600mm	D=493mm	B=2176mm	C=600mm	D=493mm
	F=322mm	G=151mm	H=120mm	F=322mm	G=151mm	H=120mm
	I=45mm	J=40.7mm	K=24mm	I=45mm	J=40.7mm	K=24mm
	L=52mm	M=73mm	N=25mm	L=52mm	M=73mm	N=25mm
	B=77-7/8"	C=23-5/8"	D=19-3/8"	B=85-3/4"	C=23-5/8"	D=19-3/8"
	F=12-5/8"	G=6"	H=4-6/8"	F=12-5/8"	G=6"	H=4-6/8"
	I=1-6/8"	J=1-5/8"	K=1"	I=1-6/8"	J=1-5/8"	K=1"
	L=2"	M=2-7/8"	N=1"	L=2"	M=2-7/8"	N=1"
700 mm (27-1/2")	B=1954mm	C=700mm	D=593mm	B=2176mm	C=700mm	D=593mm
	F=372mm	G=151mm	H=120mm	F=372mm	G=151mm	H=120mm
	I=45mm	J=40.7mm	K=24mm	I=45mm	J=40.7mm	K=24mm
	L=52mm	M=73mm	N=25mm	L=52mm	M=73mm	N=25mm
	B=77-7/8"	C=27-1/2"	D=23-3/8"	B=85-3/4"	C=27-1/2"	D=23-3/8"
	F=14-5/8"	G=6"	H=4-6/8"	F=14-5/8"	G=6"	H=4-6/8"
	I=1-6/8"	J=1-5/8"	K=1"	I=1-6/8"	J=1-5/8"	K=1"
	L=2"	M=2-7/8"	N=1"	L=2"	M=2-7/8"	N=1"
800 mm (31-1/2")	B=1954mm	C=800mm	D=693mm	B=2176mm	C=800mm	D=693mm
	F=422mm	G=151mm	H=120mm	F=422mm	G=151mm	H=120mm
	I=45mm	J=40.7mm	K=24mm	I=45mm	J=40.7mm	K=24mm
	L=52mm	M=73mm	N=25mm	L=52mm	M=73mm	N=25mm
	B=77-7/8"	C=31-1/2"	D=27-1/4"	B=85-3/4"	C=31-1/2"	D=27-1/4"
	F=16-5/8"	G=6"	H=4-6/8"	F=16-5/8"	G=6"	H=4-6/8"
	I=1-6/8"	J=1-5/8"	K=1"	I=1-6/8"	J=1-5/8"	K=1"
	L=2"	M=2-7/8"	N=1"	L=2"	M=2-7/8"	N=1"

Please find the reference to the dimensions stated in this table in Figure 31

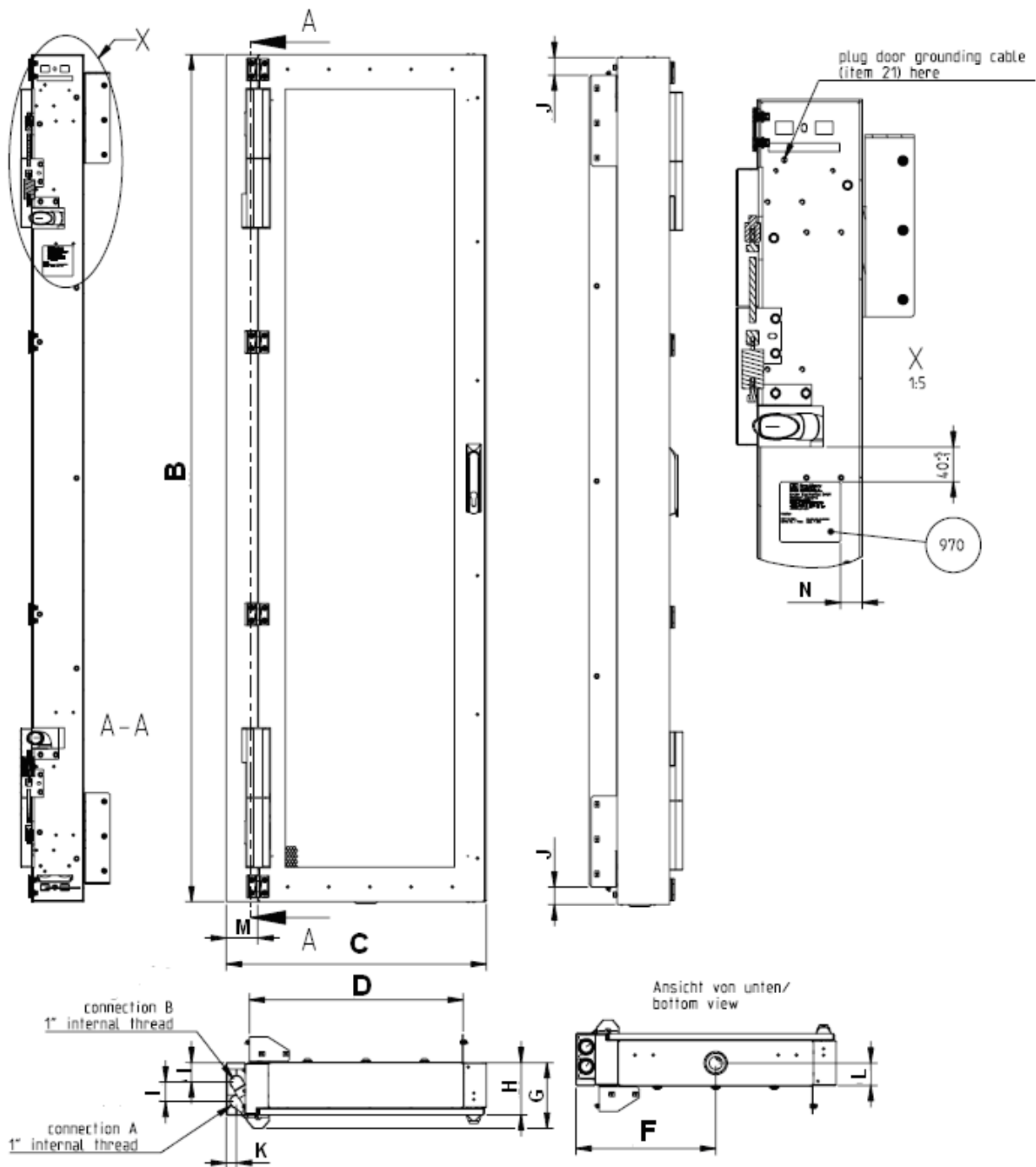

Figure 31 Submittal drawings – Knürr DCD

(1 mm = 0,0394 in.)

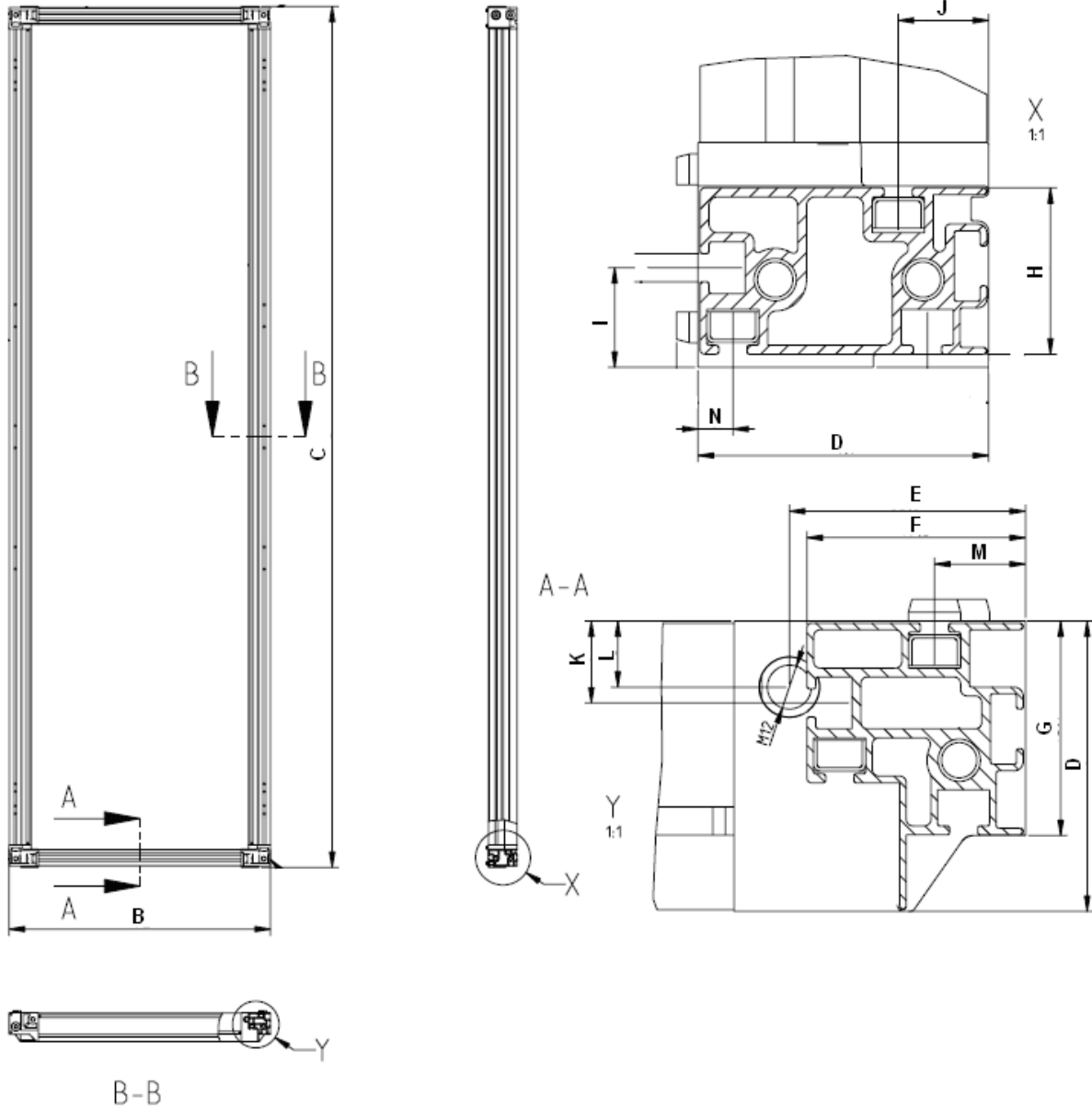

Figure 32 Aluminium frame submittal drawing

(1 mm = 0,0394 in.)

Table 7 Aluminium frame dimensions

[mm]	[in]
B=592mm C=1954mm D=65.9mm E=53.5mm	B=23-2/8" C=76-7/8" D=2-5/8" E=2-1/8"
F=49.5mm G=48.7mm H=37.7mm I=22.6mm	F=2" G=1-7/8" H=1-1/2" I=7/8"
J=20.5mm K=18.6mm L=15mm M=20.6mm	J=6/8" K=6/8" L=5/8" M=6/8"
N=7.9mm	N=2/8"

Table 8 Technical specifications

Cooling air

Housing material	Steel plate (powder coated)
Operating ambient temperature	10 °C ÷ 35°C (50 °F – 95 °F) (<i>other temperatures on request</i>)
Maximum absolute air humidity on site	8 g · kg ⁻¹
Air outlet temperature	18 °C ÷ 27 °C (64.4 °F – 80.6 °F) (<i>in accordance with ASHARE</i>)
Air temperature difference IN - OUT	15 K ÷ 20 K

Chilled water

Cooling performance	
DCD35	35kW
DCD50	50kW
Chilled water temperature inlet	12 °C ÷ 18 °C (53.6 °F – 64.4 °F)(<i>other temperatures on request</i>)
Chilled water temperature outlet	18 °C ÷ 24 °C (64.4 °F – 75.2 °F)(<i>other temperatures on request</i>)
Maximum operating pressure	10 bar (145 psi)
Pipe connection IN / OUT	1" female threaded (28xR1 EN10226-1)

5 Variants and options

5.1 Knürr DCD built in the server rack (Optional)

Knürr DCD is typically delivered as a part of a specially prepared server rack. The DCM server rack offers guaranteed air separation between the hot and the cold air within the cabinet.

(For a detailed description check the "Knürr DCM" manual)



Figure 33 Server rack with the Knürr DCD

5.2 DCD Module Active

5.2.1 Technical Specifications

Grid feed-in Supply A, B		Single 110/230V	A/B 230V	A/B 110V
Operating voltage		95...264 V, 47...63Hz	190...264 V, 47...63Hz	95...126 V, 47...63Hz
Rated current		11/5 A (110/230 V)	5 A	11 A
Fuses		12/10 A T	10 A T	12 A T
External Temperature Sensors				
Output voltage		5 V		
Output current		max. 50 mA		
Communication type		OneWire		
Usable types		Liebert SN-T Maxim DS28EA00, DS18B20		
IP Interface				
Communication type		RS485, 3,3V		
Data rate		9600 baud		
Mechanical Data		H2000	H2100	H2200
Dimensions (L x W x H)	DCD35	1954 x 420 x 125 mm	2088 x 420 x 125 mm	2176 x 420 x 125 mm
	DCD50	1954 x 579 x 125 mm	2088 x 579 x 125 mm	2176 x 579 x 125 mm
Mass	DCD35	35 kg		
	DCD50	40 kg		
Degree of protection		IP20		
Degree of contamination		2		
Ambient Conditions				
Operating temperature		+10...+40 °C		
Storage temperature		-25...+80 °C		
Relative humidity		0...95 %, non-condensing		
Altitude above sea level		max. 2,000 m		

Pressure Connection

Operating pressure	-250...+250 Pa
Maximum permissible pressure	±1 bar
Tolerance	3 % of the measured value ±0.2 Pa
Working gases	Air, nitrogen
Hose – outer diameter	6 mm

5.2.2 General

5.2.2.1 Intended use

The fan module DCD35/50 Active must be assembled and operated only with server cabinet doors made by Vertiv (Cool Door) for which it has been designed. The fan module must be operated only if installed in the server cabinet door. The server cabinet door represents the rear cover of the fan module.

The fan module has been designed for use in a controlled environment, such as data centres or server rooms. The ambient conditions as set out in the product specifications must be observed.

All materials required for installation and commissioning come with the unit. The external fuses as described in the product specifications and on the rating plate shall be provided for in the installation. The various indications for the different supply voltages shall be observed.

5.2.2.2 Repair during operation

In order to guarantee high availability of the DCD35/50 Active – and, therefore, for the entire server – , it is possible for skilled staff to perform certain repairs while the fan module is running.



ATTENTION

Hazard of accident or injury

There is a hazard of being injured by electrical shock and by rapidly rotating parts!

Repairs during operation must be performed only by skilled experts with sufficient understanding of the subject, knowledge of the hazards as well as with appropriate personal protection equipment!

5.2.2.3 Functional description

After their correct installation and connection with the supply voltage, the fans run up for about 5 s at 50 % of their maximum speed. Thereafter, the fan speed is steadily controlled by the differential pressure measured. The differential pressure is measured between the two pressure connections of the unit. Thereby, the lateral connection measures the ambient pressure, and the upper connection measures the internal pressure in the server by way of the installed pressure hose. The controls regulate the speed rate of the fans in such a way that the predefined setpoint differential pressure is reached. The default setpoint differential pressure is 0 Pa. On units with a TFT display, the user can preselect the setpoint differential pressure in steps in the TFT menu. These steps can be set in the TFT setup menu (password-protected).

5.2.2.3.1 Standard version

In its standard version, the DCD35/50 Active is equipped with a single wide-range voltage input port (110/230V). No temperature sensors, nor a TFT display are provided. A green operating LED and a red disturbance LED have been provided for status control.

5.2.2.3.2 Redundant power supply A/B (option)

With the optional A/B feed-in (110 V or 230 V), the unit has two separate feed-ins from the grid (Supply A and Supply B). As soon as voltage from the grid is supplied to Supply A, the unit is supplied from this input port. If the power supply to Supply A terminates, the unit switches internally to Supply B, from where it is then supplied. The respectively corresponding unit version needs to be ordered for grid voltages 110 V or 230 V.

5.2.2.3.3 Monitoring by TFT display and temperature sensors (option)

The temperatures inside the server as well as in the fan module (after the heat exchanger in the Cool Door) can be measured and represented by way of the optional TFT display and temperature sensors. Moreover, the colour TFT display can show the setpoint and actual speed rates of the fans, and the status of the unit can be monitored. This provides the user with the additional possibility to take influence on pressure control. The service technician has the chance to parameterize the unit in the password-protected setup menu.

5.2.3 Installation and Commissioning



ATTENTION

The assembly must be performed only when the unit is disconnected from power!

For that purpose, the grid feed-in (Supplies A and B) shall be removed or all poles disconnected!

Local safety regulations must be observed!

The following notes must be complied with for proper functionality!

Please note the assembly instruction for the Cool Door (made by Vertiv) for attaching the fan module to the server door. Prior to assembly, the hood cover of the DCD35/50 Active must be removed. For that purpose, the PE wire (protection earthing) can be pulled from the PE connector pin. Before re-attaching the hood cover, the PE wire needs to be pushed onto the PE connector pin again.



Figure 34 Disassembly of the hood cover

Figure 35 PE connector pin

For attaching the DCD35/50 Active to the server door, the screws of the lower mount must be loosened (not removed!) and the mount be pulled out downward to the limit stop. The fan module can then be hung onto the Cool Door with its upper mount. For fixation, the lower mount must then be pushed in again and the screws fastened. The image demonstrates the intended fastening for attachment to the server door.

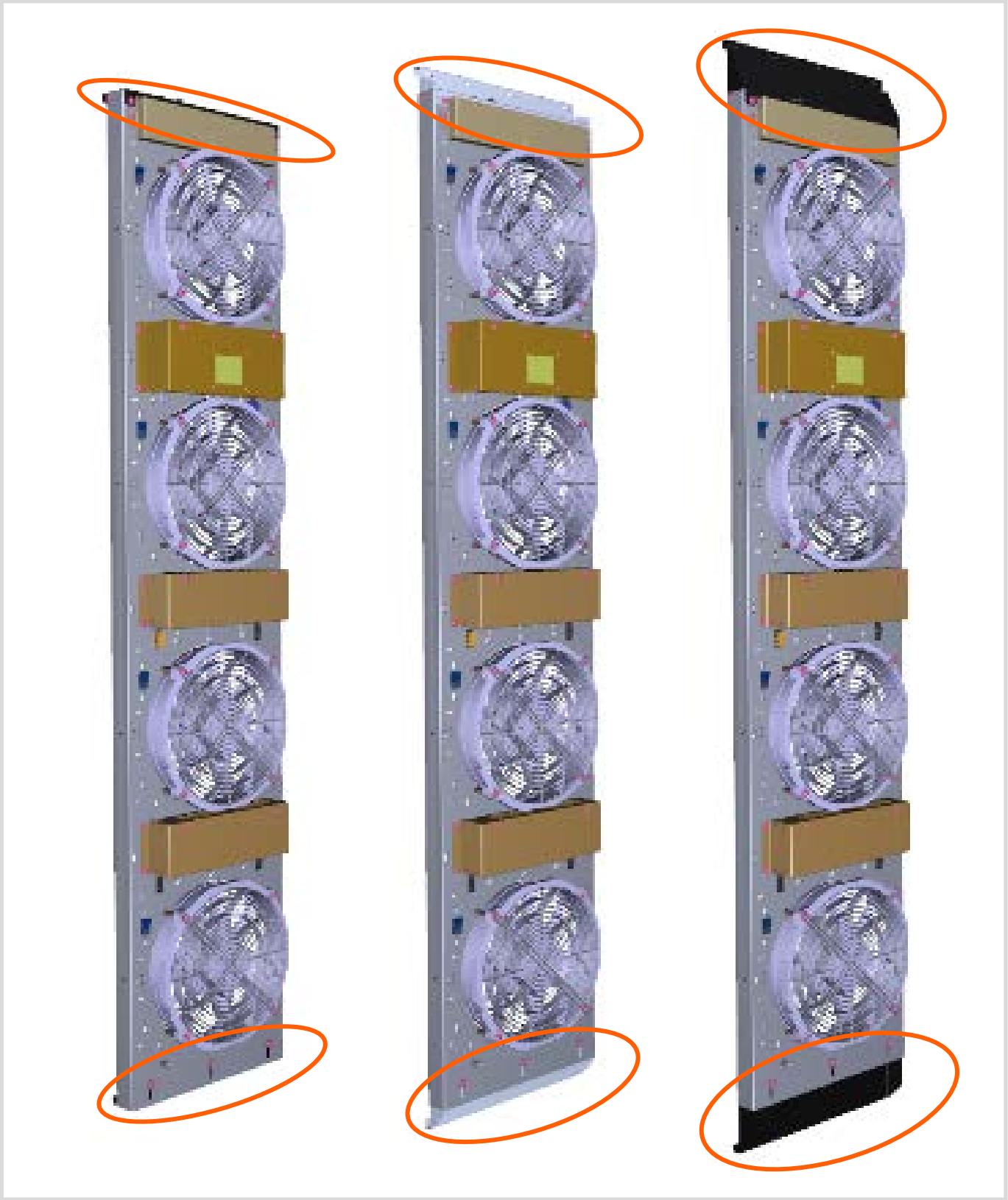

Figure 36 Upper and lower mounts of the DCD35 Active for attaching it to the DCD (H2000, H2100, H2200)

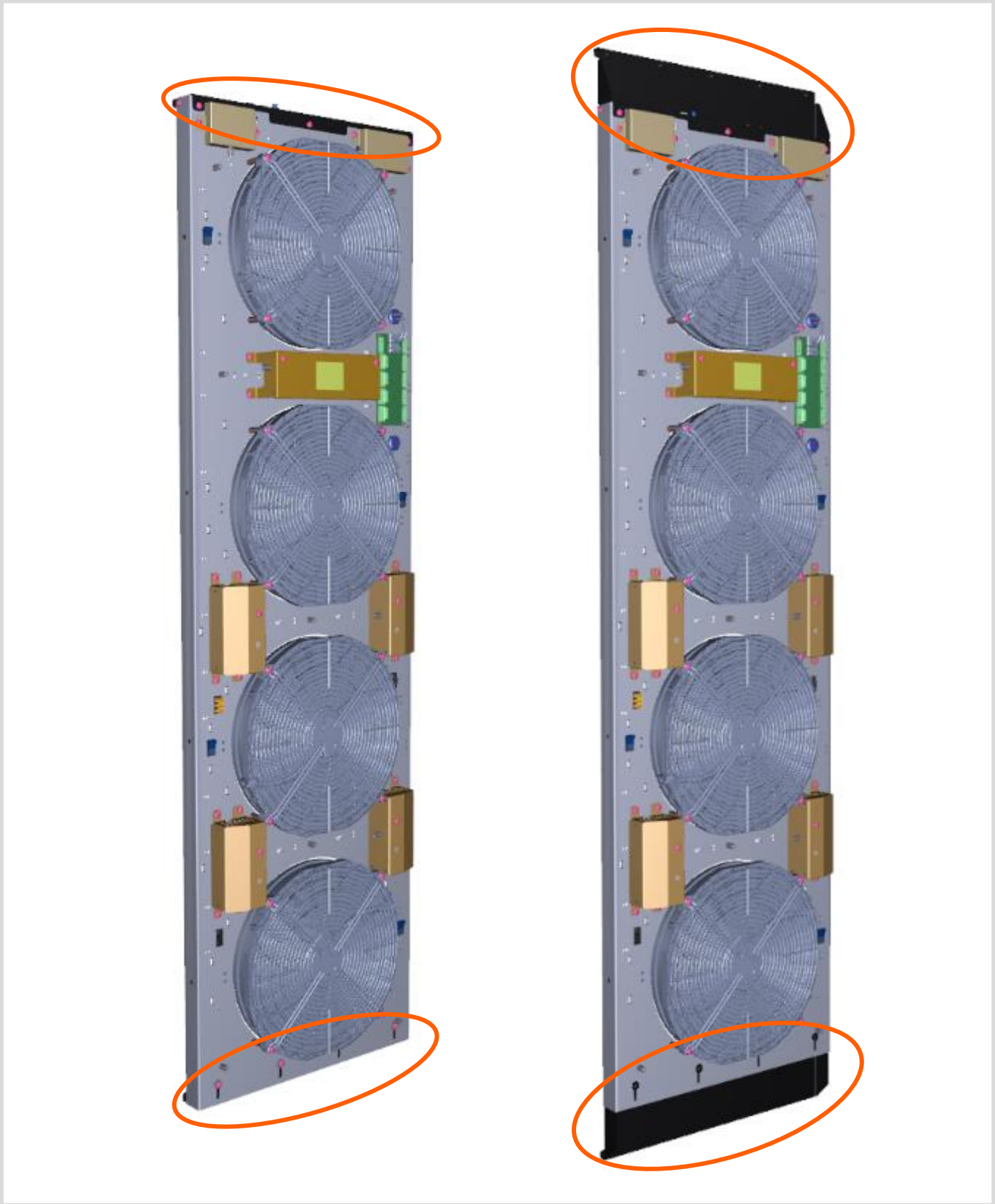

Figure 37 Upper and lower mounts of the DCD50 Active for attaching it to the DCD (H2000, H2200)

The supply lines and the pressure hose must be connected and fixed with the wire bridges. The optional temperature sensors, which are placed inside the server, must be connected to the RJ45 socket. Sensors connected for the first time, must be taught-in during commissioning.

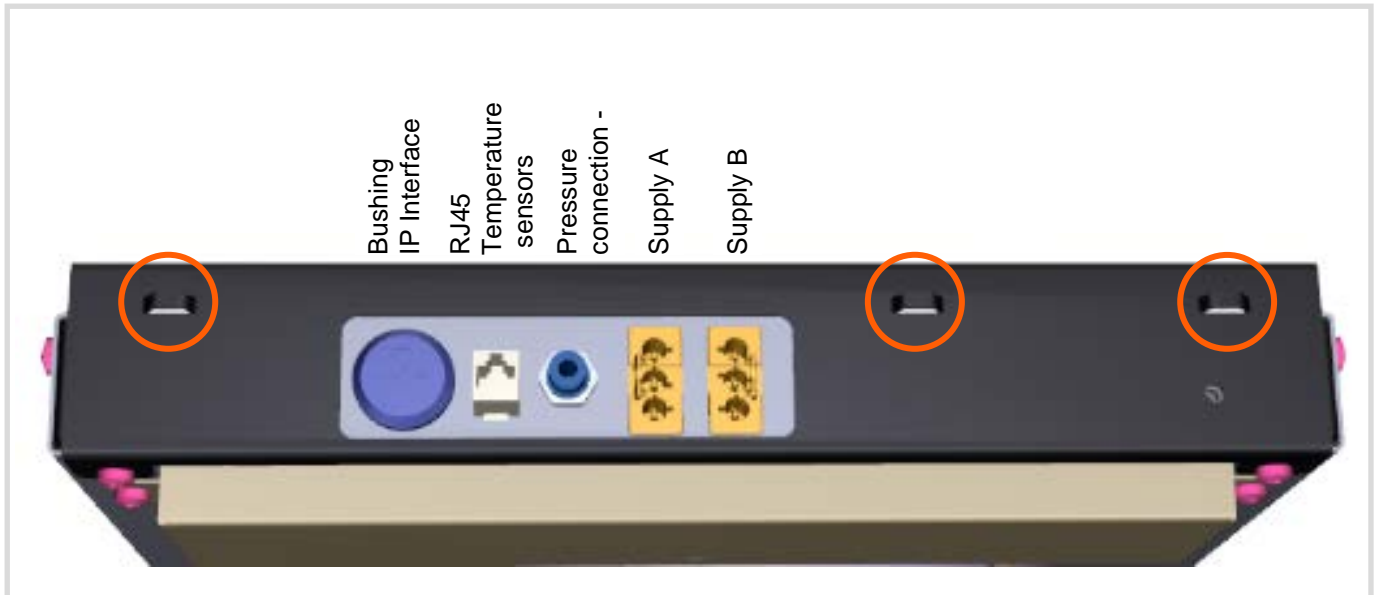

Figure 38 Connections and points of wire fixation of the DCD35 Active (H2000)

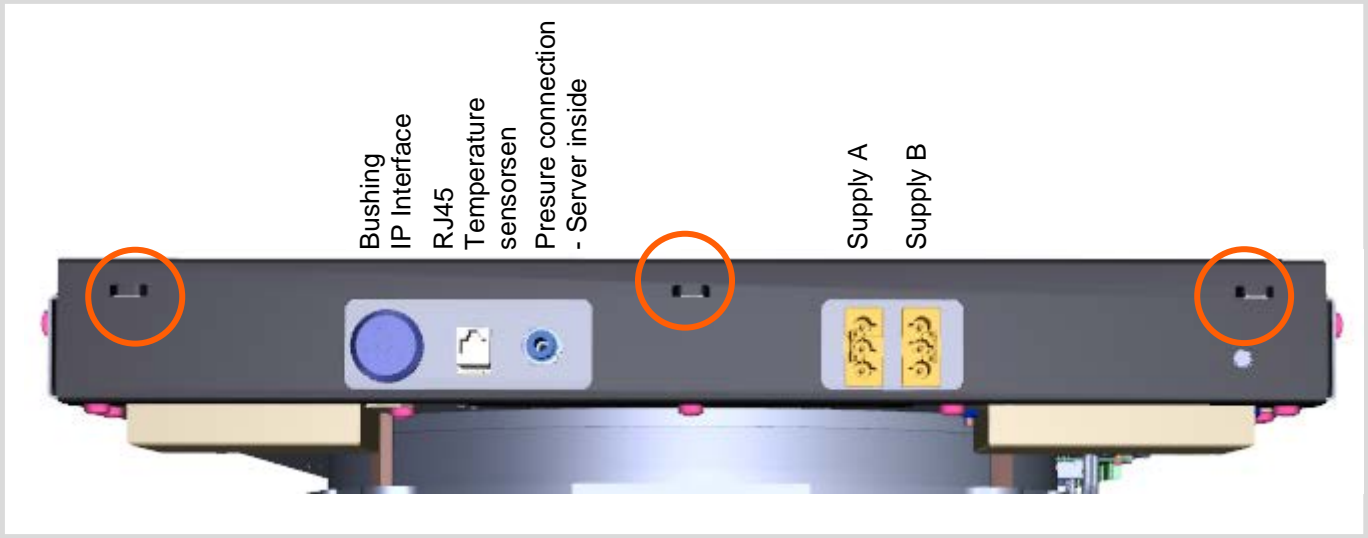

Figure 39 Connections and points of wire fixation of the DCD50 Active (H2000)



Figure 40 Points of wire fixation of the DCD35/DCD50 Active (H2200)



CAUTION

The PE contacts of terminals Supply A and B must be connected to PE (protective earth) of the electrical system! Otherwise, there is a risk of electric shock if the metal housing is touched in the event of a fault!

I NOTE

Prior to hooking up to power supply, respective testing as prescribed by local safety regulations must be performed.

After the fan module has been assembled and all connections have been provided, power can be supplied. The unit will immediately start and, after a short time, will independently begin to control the differential pressure. The green operating LED (Standard) will shine or the TFT display (optional) will start showing the startup screen and immediately thereafter jump to the main screen.

5.2.3.1 Option of connecting an alarm contact



CAUTION

This must only be carried out by qualified personnel with sufficient expertise, knowledge of the hazards and appropriate protective equipment!

The work described here means changing the unit. The skilled person carrying out the work must ensure that the upgrading does not impair the safety of the device. All technical specifications and instructions must be followed!

A potential-free normally closed (NC) contact is provided at the central control unit of the DCD35/50. This contact is used for error messages to higher-level systems. It opens when a fault is present (analogous to the red LED) and is closed when no fault is present (analogous to the green LED). In the voltage-free state, the contact is open.

Technical characteristics alarm contact	
Max. Voltage / Current	30 VDC / 0,5 A (externally fused)
Terminal characteristics	0,5 mm ² - 1,0 mm ² , rigid or flexible with wire end ferrule
Cable characteristics (cable not included)	
Type	Single wire or sheathed cable, 0.5 mm ² - 1.0 mm ²
Approvals	Depending on location: H05V-K / IEC60228 / VDE0295 / UL758 / CSA C22.2

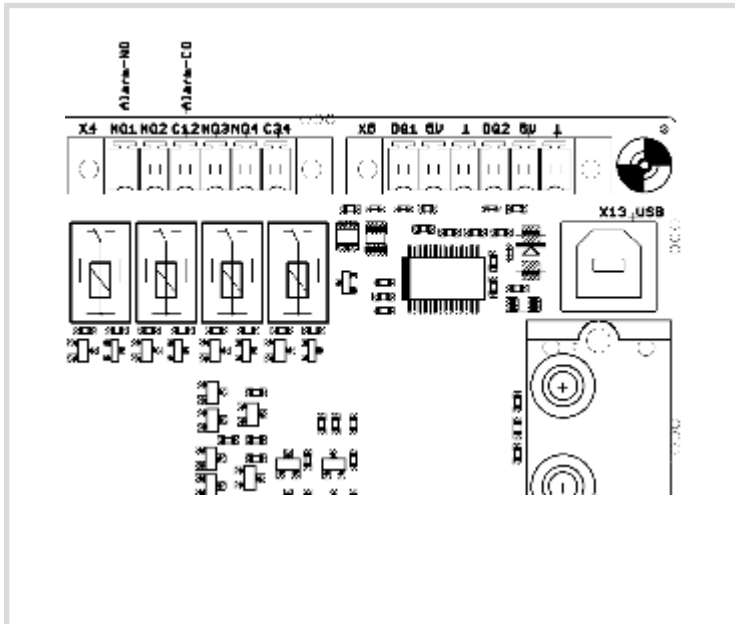

Figure 41 central control, alarm connections

Connect the alarm cable to the central controller at terminals X4.NO1 and X4.C12 (Figure 8).

The cables must be routed as shown in Figure 41. They must be fixed to the housing with cable ties in such a way that they cannot reach the fans or areas with voltage-carrying parts.

The cable can be led out through the cable grommet on top of the DCD. The cable has to be fixed to the housing with cable ties.

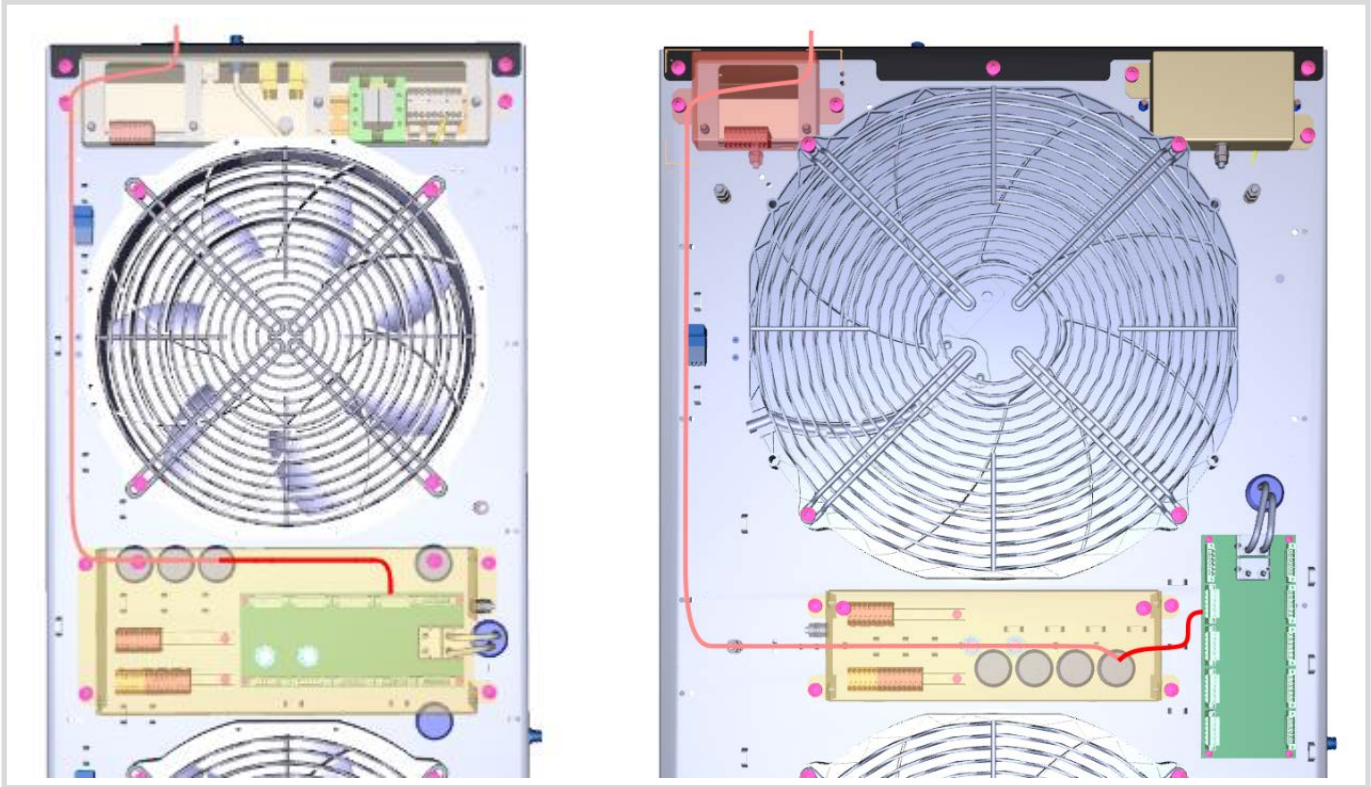

Figure 42 Installation of alarm cable, red - top side, pink - underside of the basic housing, lead through cable grommet.

5.2.4 Operational Handling

For the Standard version, no operational handling of the unit is possible. After power has been provided, the unit will run independently to control the differential pressure. The unit can be handled operationally only if equipped with the optional TFT display.

5.2.4.1 Menu of the TFT display (option)

5.2.4.1.1 Main screen with detail menus

Display of the set fan speeds in percent
The colour of the individual fan symbols shows Operation OK (green) or Disturbance (red)
Touching on the area leads on to the detail menu of RPM Display

Display of the average temperature of all exhaust-air temperature sensors installed in the fan module (cold side).
Touching on this area leads on to the detail menu of Exhaust-air Temperatures.

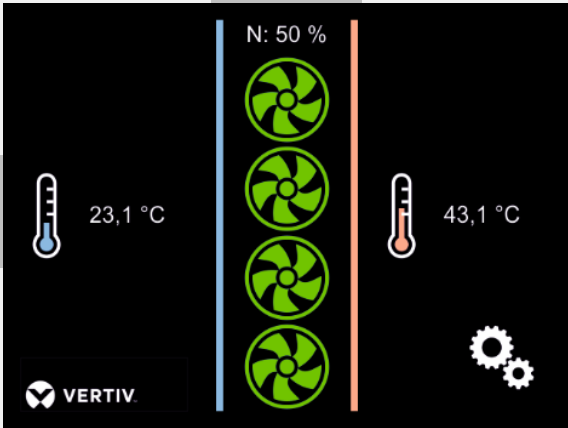

Display of the average temperature of all temperature sensors installed in the server cabinet (hot side).
Touching on this area leads on to the detail menu of Server-cabinet Temperatures.

Touching on here leads on to the settings menu

Figure 43 Main screen

The main screen of the TFT display is a black rectangle. At the top center, it displays 'N: 50 %'. Below this, there are four green fan icons arranged vertically. To the left of the fans is a blue thermometer icon and the text '23,1 °C'. To the right is a red thermometer icon and the text '43,1 °C'. At the bottom left is the VERTIV logo. At the bottom right is a gear icon. The screen is surrounded by grey callout boxes with arrows pointing to specific areas.

The colour of the individual fan symbols shows Operation OK (green) or Disturbance (red)

Display of the set fan speeds in percent

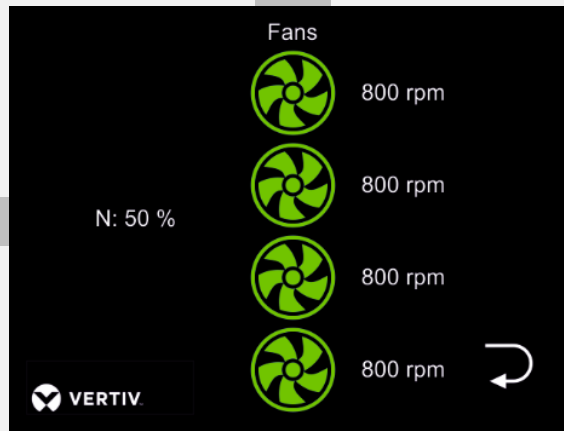

Display of actual fan speeds

Figure 44 Detail menu Fans

Touching on here returns to the main menu.

Display of the average temperature of all exhaust-air temperature sensors installed in the fan module (cold side).

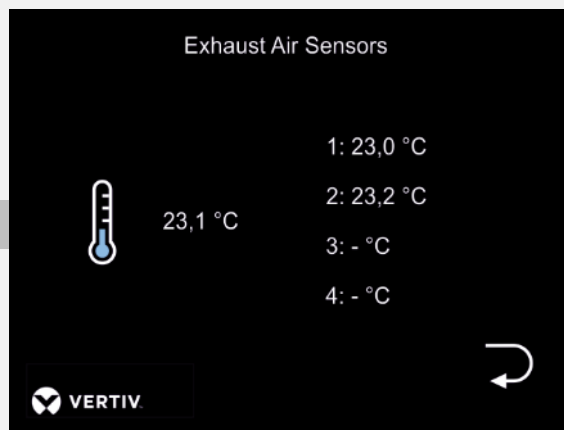

Display of the individual sensor measurements.
The average value displayed on the left is calculated from them.

Figure 45 Detail menu of Exhaust Air Sensors

Touching on here returns to the main menu.

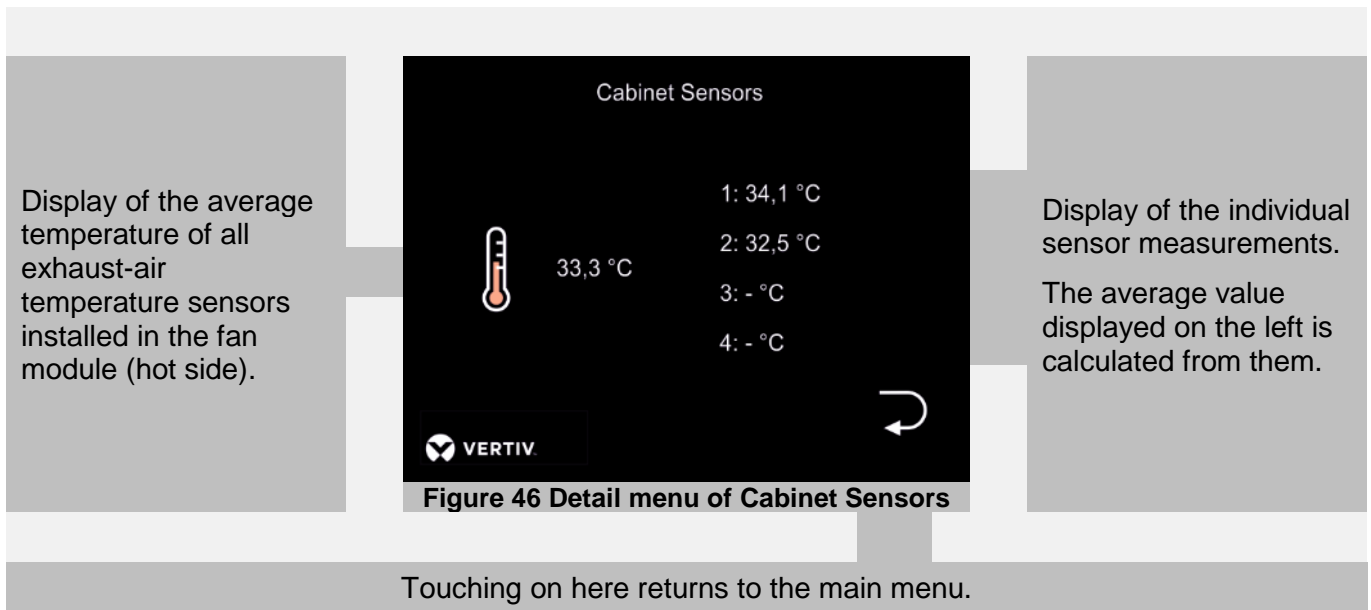

5.2.4.1.2 Menu settings

Touching on here leads to the password-protected setup menu.
Password: 94424

Figure 47 Menu Settings

Touching on here leads to the respective sub-menu:

- info
- messages
- temperature Sensors
- regulation

Touching on here returns to the main menu

There is no handling of controls in the sub-menus Info and Messages. Therefore, they are not shown here.

Touching on here leads to the sub-menu:
choose Units

Figure 48 Sub-menu Temperature Sensors

Touching on here leads to the sub-menu:
Teach Cabinet Sensors

Touching on here leads to the settings menu.

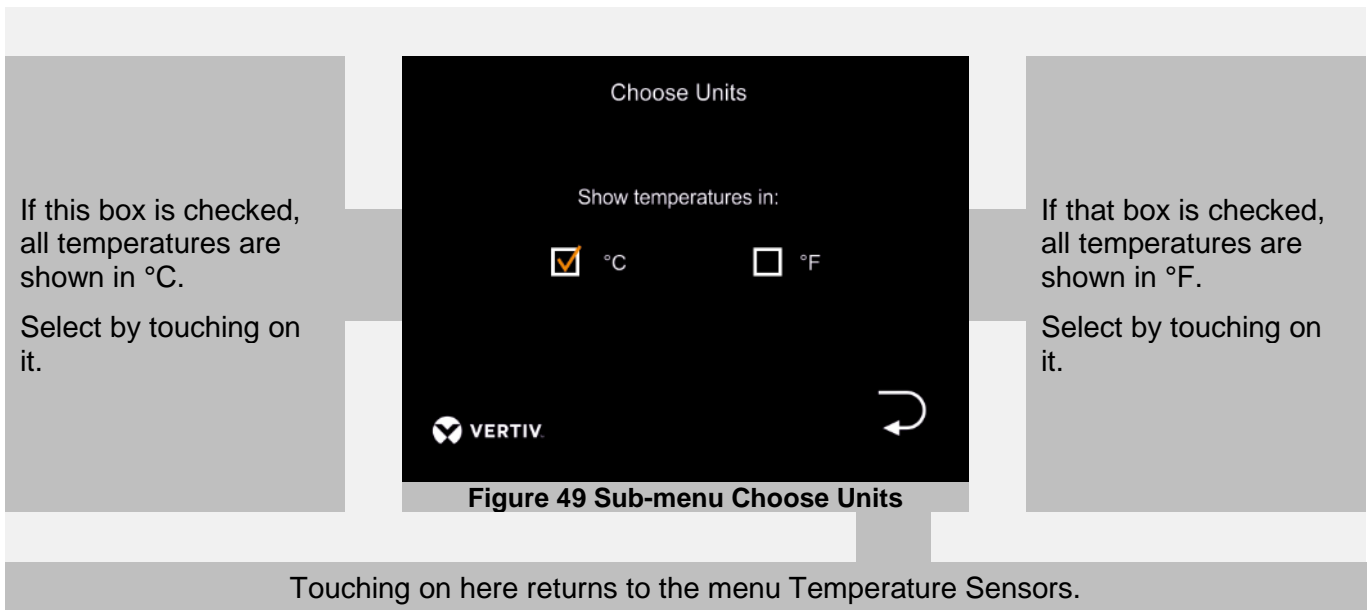

The user can teach-in the sensors in the server exclusively.

The sensors in DCD35/50 Active can be taught-in only in the password-protected Setup Menu.

Choose sensor No.
1...4
Go down in sensor
number.

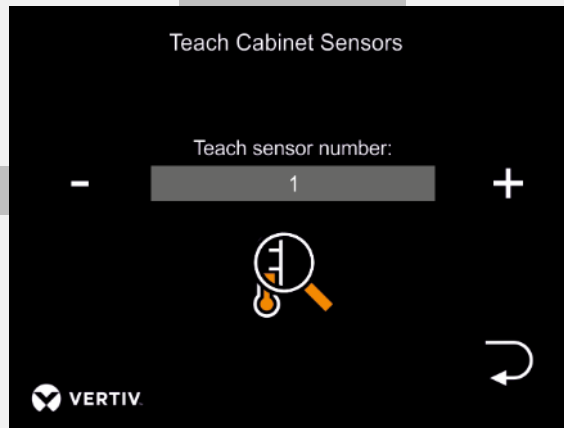

Choose sensor No.
1...4
Go up in sensor
number.

Figure 50 Sub-menu Server Teach Cabinet Sensors

Start teaching-in the selected sensor number.

Touching on here returns to the
menu Temperature Sensors.

Selection of the
setpoint value of the
differential-pressure:
Slight excess
pressure
neutral
Slight under
pressure
choose lower level.

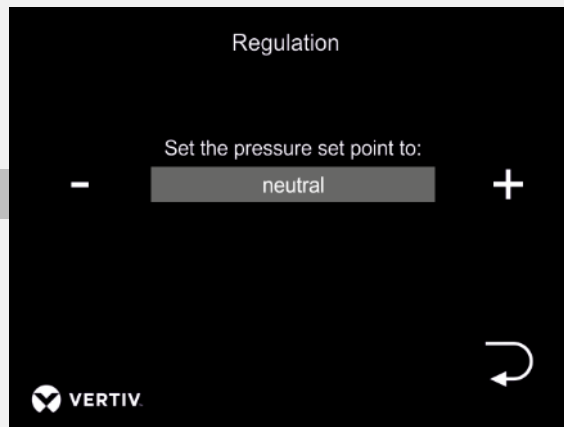

Selection of the
setpoint value of the
differential-pressure:
Slight excess
pressure
neutral
Slight under
pressure
Choose higher
level.

Figure 51 Sub-menu Regulation

Touching on here returns to the main menu

5.2.4.1.3 Setup Menu

Touching on here leads to the sub-menu:
Pressure Levels

Touching on here leads to the sub-menu:
Teach Exhaust Air Sensors in DCD35/50.

Touching on here leads to the settings menu.

Figure 52 Setup menu

For the purpose of repair, the internal sensors in the fan module can be taught-in here.

Choose sensor No. 1...4
Go down in sensor number.

Choose sensor No. 1...4
Go up in sensor number.

Start teaching-in the selected sensor number.

Touching on here returns to the Settings menu.

Figure 53 – Sub-menu Teach Exhaust Air Sensors in the DCD35/50

Selection of the setpoint value of the differential-pressure in levels that can be selected by the user:

Slight excess pressure
neutral
Slight under pressure
Decrease the value.

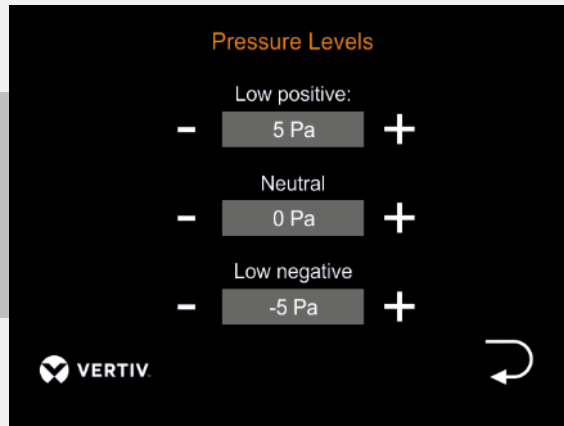

Figure 54 Sub-menu Pressure Levels

Selection of the setpoint value of the differential-pressure in levels that can be selected by the user:

Slight excess pressure
neutral
Slight under pressure
Increase the value.

Touching on here returns to the Settings menu.

5.2.4.2 Teaching-in the temperature sensors

When taking the unit into operation, the (optionally) included temperature sensors must be taught-in. For purposes of repair, the service technician may also teach-in the sensors that are (optionally) installed inside the DCD 35/50 Active via the Setup menu. The approach of teaching-in is the same in both sensor circuits, and, therefore, it is demonstrated here by example of screenshots of the Server Cabinet Sensors.

I NOTE

For teaching-in a sensor, make sure a single sensor is connected only. Otherwise, teaching-in will fail. As the sensor circuits of the Server Cabinet Sensors and of the internal sensors in the DCD35/50 Active are separate, this applies respectively only to the sensor circuit concerned.

A sensor once correctly taught-in is saved by the DCD35/50 Active. As soon as a once taught-in sensor is connected, its temperature is measured by the unit. For teaching in several sensors one by one, a once taught-in sensor can be disconnected again and re-connected later without any concern.

For teaching in a sensors, the following steps shall be worked down in the indicated sequence.

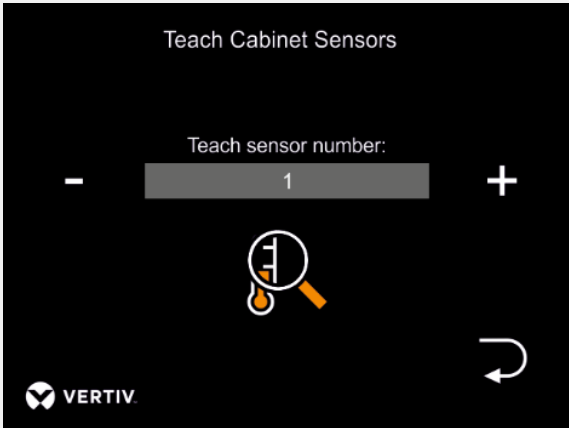
Step	Menu	Description
1	-	<ul style="list-style-type: none"> Disconnect all sensors, except the one to be taught in from the sensor circuit in question.
2		<ul style="list-style-type: none"> Select the number to be given to the new sensor from the menu "Teach Sensor" (logical numbering up or down appropriate to the fan positions eases later sensor localisation) Touch on the symbol of the magnifying glass to continue teaching <p>Additional notes:</p> <ul style="list-style-type: none"> In order to delete an already taught-in sensor, the teaching process for that sensor number can be continued without the sensor connected. An already assigned sensor number is assigned to the new sensor by renewed teaching.

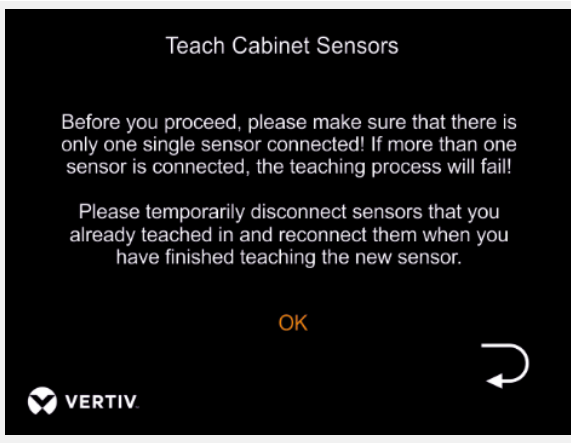
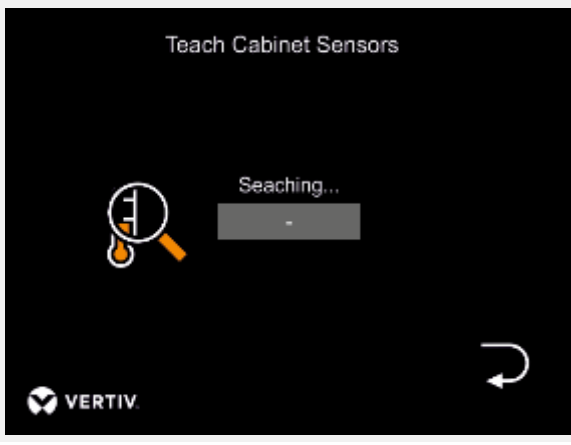
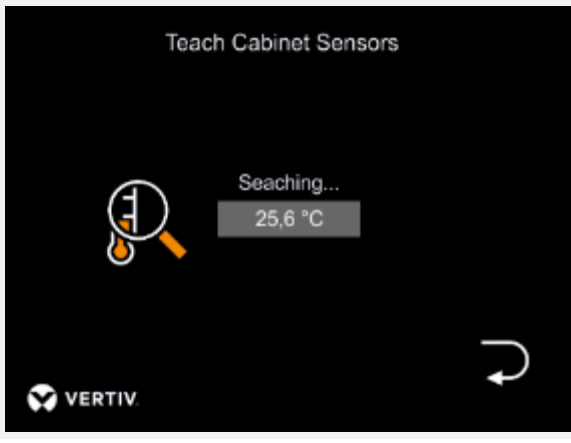
<p>3</p>		<ul style="list-style-type: none"> • Before starting the teaching process, another note will appear. • OK will start the teaching process. • Abortion by touching on the return arrow.
<p>4</p>		<ul style="list-style-type: none"> • " - "- is displayed during the search process. • This process takes only a few seconds. • Abortion by touching on the return arrow.
<p>5</p>		<ul style="list-style-type: none"> • As soon as the sensor has been taught in successfully and saved, its temperature is shown. • Touching on the return arrow will take you back to the selection of sensors, and the next sensor can be taught in beginning from Step 1.
<p>6</p>	<p>-</p>	<ul style="list-style-type: none"> • As soon as all sensors have been taught, the sensors that had been disconnected for the teaching process can be re-connected.

5.3 Connection set Knürr DCD (optional)

This set is for recommended connection of the Knürr DCD with the on site chilled water system.

Part no. 08.009.066.0

Knürr DCD connection set consists of

- **Reinforced hose with nickel - plated connections**

EPDM resistant to water and anti-freeze

Temperature range	0 °C ÷ 110 °C (32 °F – 230 °F)
Maximum operating pressure	10 bar (145 psi)
Inner diameter	25 mm (1")
Connection	1" F / 1" M (DIN ISO 228 - 1)
Length	1500 mm (59,1")

(1 mm = 0,0394 in.)

- **Ball valve with fitting**

Ventilation and drain connection $\frac{3}{4}$ "; possibility of pressure and temperature measurements.

Connection 1" F (DIN ISO 228 - 1)

- **Shut off and regulation valve**

Discharge vent $\frac{3}{4}$ "; possibility of pressure and temperature measurements.

Connection 1" F (DIN ISO 228 - 1)

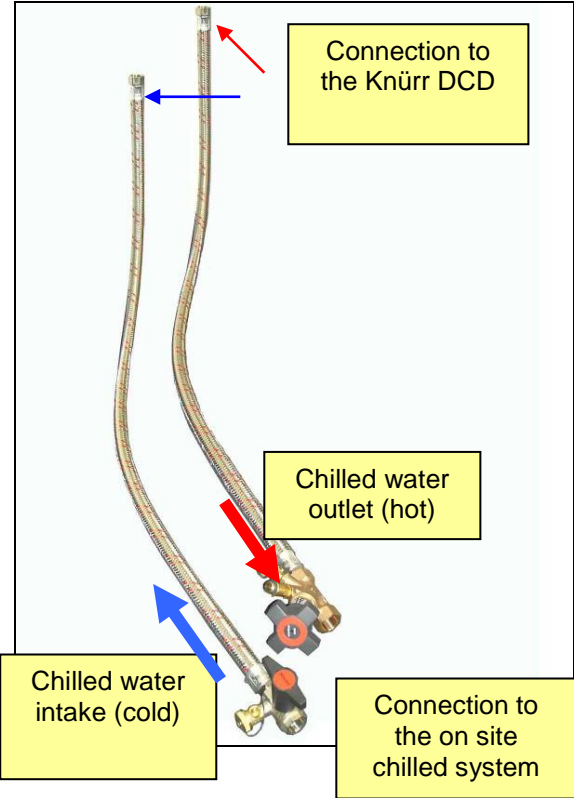

Figure 55 Connection set

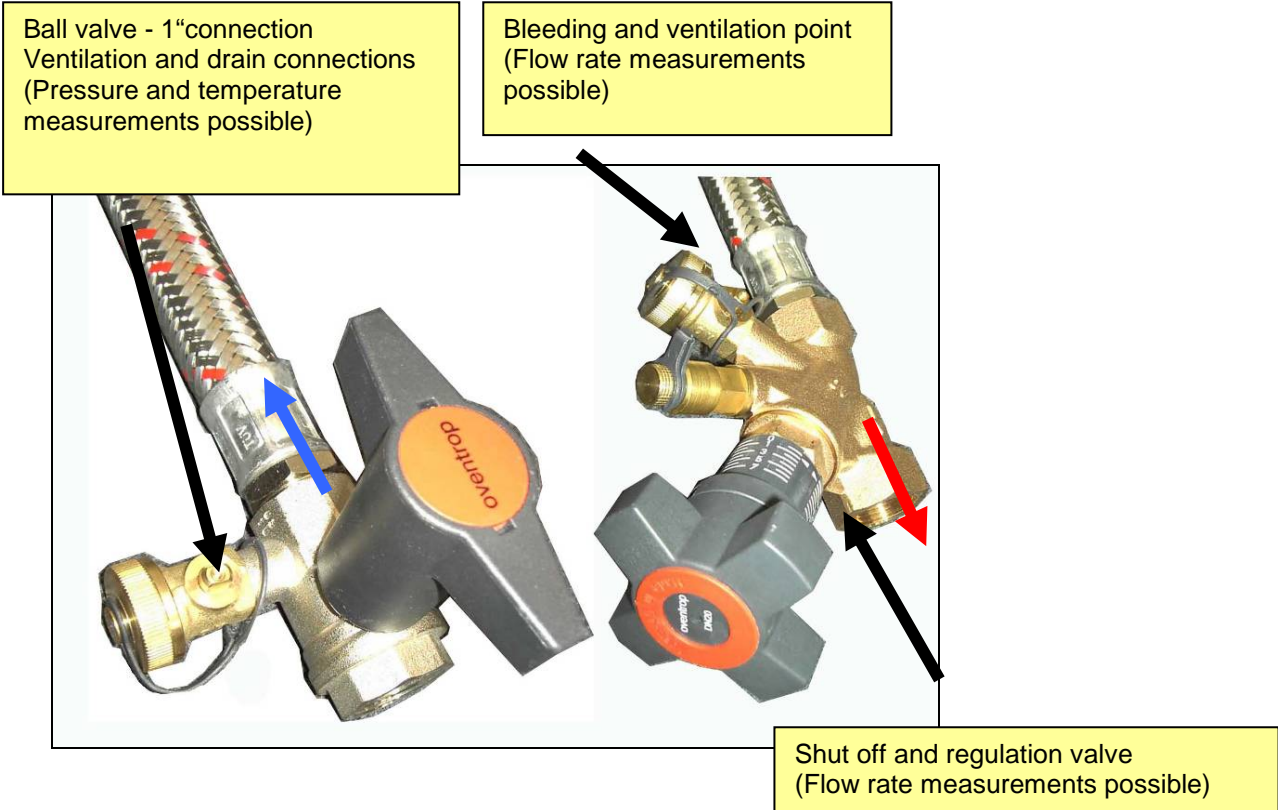

Figure 56 Connection set - detail

(Note: All parts of the set are supplied as individual parts and are connected by the customer)

Knürr DCD

User's Manual

5.4 Spacing kit and BSP to NPT adapter (optional)

It might be necessary to extend the distance between the supply and the return pipes as well as change the connection thread. For this purpose, it is possible to order the pipe spacing kits. Each kit contains set of 2 hoses (for supply and return). One end of the hose is always fitted with R1" thread for connection to the DCD.

For installation with NPT connections a set of 2 adapter for a connection from 1" BSP female to 1" NPT male can be ordered.

Table 9 Spacing kit and adapter

Order number	Description
08.009.160.0	Flexible hose DN25 L300 R1" x Rp1"
08.009.164.0	Adapter BSP 1" female to NPT 1" male

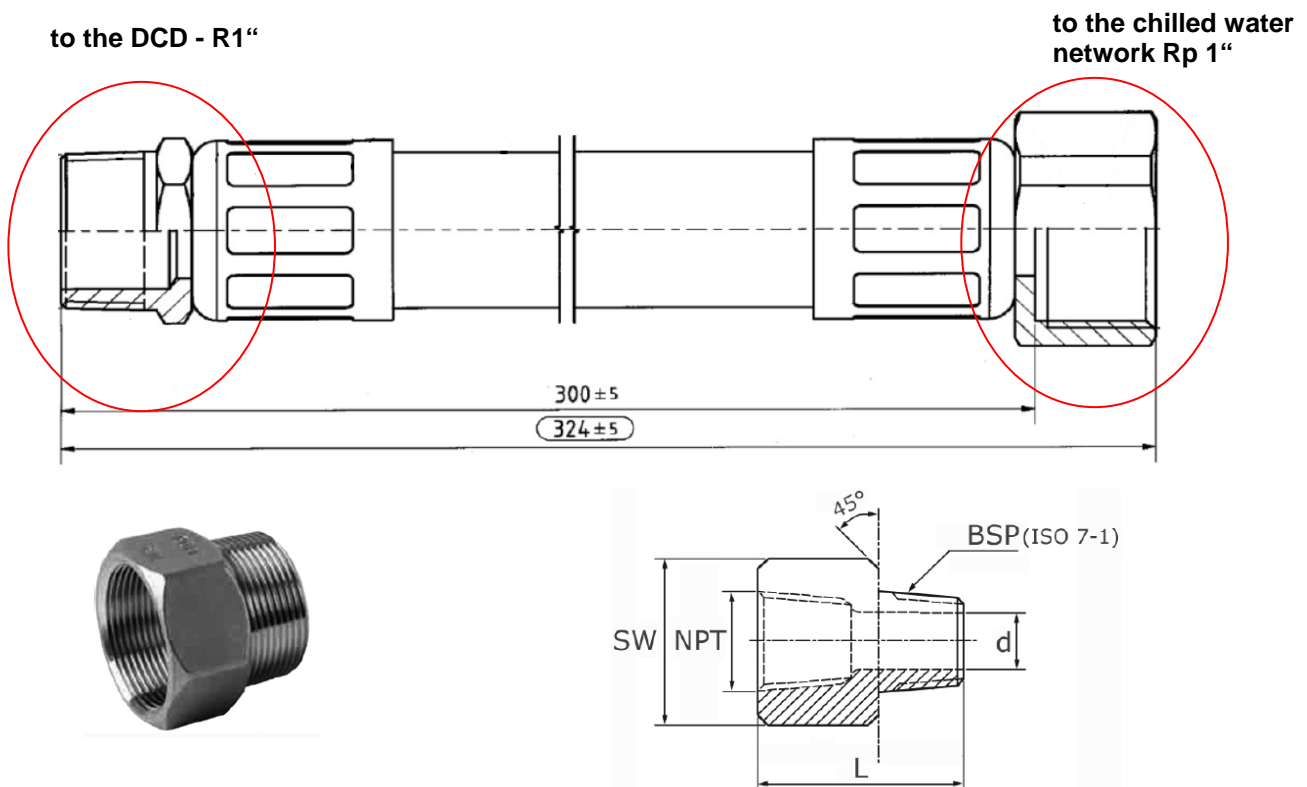









Figure 57 Spacing kit and adapter

SW 38mm, NPT 1", BSP 1", L46mm, d 26mm

6 Maintenance and repairs

	<p>All maintenance and repair jobs are to be performed by qualified personnel only. All actions must be in accordance with regulations and instructions of the manufacturer.</p>
	<p>For maintenance and repair jobs use only the tools and spare parts approved by manufacturer of the device.</p>
	<p>Before commencing any work on the chilled water system let the system drain.</p>
	<p>General maintenance actions to be carried out</p> <ul style="list-style-type: none">• Check the heat exchanger pollution (dust etc.)• Check functionality of the valves• Check the chilled water system for leaks visually
	<p>Please note that dirt (dust layer etc.) on the heat exchanger reduces the performance of the device (increased pressure loss, worse heat transfer). Vacuum cleaner, soft brush, or compressed air can be used to clean the fins of the heat exchanger.</p>

7 Disassembly and disposal

	Disassembly of the Knürr DCD may be performed by qualified personnel only.
	Shut down the chilled water system before disassembly and prevent it from restarting.
	<p>Dispose all the components and parts in accordance with local waste management and regulations. We recommend a recycling company.</p> <p>All components consist of:</p> <ul style="list-style-type: none">• Aluminum, steel, brass, copper• Marked plastic components

8 Customer service

All Knürr products are subject to continuous quality control and comply with applicable regulations. For any questions you have related to our products, please contact the manufacturer of your system directly:

Knürr GmbH
Mariakirchener Straße 38
94424 Arnstorf

Knürr DCD

User's Manual

9 Annexes

9.1 Quality Requirements for water used in the Knürr DCD

In order to safeguard the maximum lifetime of air/water heat exchangers, the water applied for chilling purposes must meet the VGB Chilled Water Guidelines (VGB-R 455 P). The chilled water used must be soft enough to prevent deposits, but it must not be too soft which would lead to corrosion of the heat exchanger.

The following table contains the most important impurities and counter-measures for their removal:

Table 10 Water quality requirements

Water impurity	Method for removal
Mechanical impurity (dp < 0.3 mm)	Filter the water
Excess hardness	Soften the water by ion exchange
Moderate level of mechanical impurities and hardeners	Add dispersion or stabilizing agents
Moderate level of chemical impurities	Add deadening agents and inhibitors
Biological impurities (bacteria and algae)	Add biocides

It is recommended to get as closest as possible to the following hydrological parameters:

Table 11 Hydrological requirements

Hydrological data		
pH values	(7 ÷ 10,5)	
Carbonate hardness	(3 ÷ 8)	°dH
Free carbon dioxide	(8 ÷ 15)	mg/dm ³
Combined carbon dioxide	(8 ÷ 15)	mg/dm ³
Aggressive carbon dioxide	0	mg/dm ³
Sulphides	< 10	mg/dm ³
Oxygen	< 50	mg/dm ³
Chloride ions	< 250	mg/dm ³
Sulphate ions	< 10	mg/dm ³
Nitrates and nitrites	< 7	mg/dm ³
COB	< 5	mg/dm ³
Ammonia	< 5	mg/dm ³
Iron	< 0.2	mg/dm ³
Manganese	< 0.2	mg/dm ³
Conductivity	< 30	µS/cm
Solid residue from evaporation	< 500	mg/dm ³

Hydrological data		
Potassium manganese consumption	< 25	mg/dm ³
Suspended matter	< 3	mg/dm ³
(partial flow cleaning is recommended)	(3 ÷ 15)	mg/dm ³
(permanent cleaning)	> 15	mg/dm ³

9.2 Checklist for Setting up the Device

Table 12 Set up checklist

Performed checks	Done (to be signed upon completion)	Remarks
Check device for damage upon receipt.		
Check the ground for being horizontal.		
Check bearing capacity of ground.		
Add-on and align, connect to server cabinet, position feet of the rack and adjust them horizontally		
Cables connected with server cabinet: <ul style="list-style-type: none"> - Temperature sensors (optional) - Server shut-down (optional) - Door contact (optional) 		
Unit connected with set of external valves (optional): <ul style="list-style-type: none"> - Valve drive - Flow meter with temperature sensors (optional) 		
Optional automatic door opening adjusted at server cabinet		
No remainders of packaging inside Knürr DCD		
All assembly tools removed		
Bushings into the device proper and air-tight		
Chilled water connection leak-proof / pressure-tested		
Chilled water system de - aerated		
Volume flow of chilled water adjusted		

Knürr DCD
 User's Manual



Condensed water line unobstructed		
Smell trap of chilled water system functional		
Condensate tray connected to condensed water line		
All front panels closed (air ducts technically separated)		

.....
 Place:

.....
 Date:

.....
 Signature
 of Engineer

9.3 Commissioning Protocol

Knürr DCD Commissioning Protocol

1 General Details

1.1 Customer/Site of installation

Customer's name:

Customer's address:

.....

.....

Contact partner:

Phone number:

Site of installation / room number:

Humidity at site of installation: % rel. humidity

Ambient temperature ° C

1.2 Configuration

Cabinet type:

Knürr DCD 35 kW

Knürr DCD 50 kW

Commissioning number (if applicable):

Serial number:

Special remarks:
.....
.....
.....

2 State Check

2.1 General State

Customer's proof of bearing capacity of ground / transport ways

Check of alignment

Transport damage to housing: yes no

Remarks

.....
.....
.....

Residual packaging removed: yes no

Assembly tools removed: yes no

Air ducts checked: yes no

(Server cabinet front plates closed...)

3 Functional Check

3.1 Mechanical Functions

Damage to heat exchanger/

Connections/ lamellas / surface: none existing

Remarks:

.....

Front door, closing: yes no

Remarks:

.....

Rear door, closing: yes no

Remarks:

.....

Pipe duct inlets / cable bushings closed: yes no

Remarks:

.....

Condensed water drain open / connected: yes no

remarks:

.....

Fans run perfectly (bearings OK)

Visual check yes no

Remarks:

.....

3.2 Thermodynamic Checks

Condensed water forming at heat exchanger yes no

Remarks:

.....

Chilled water entering heat exchanger: ° C

Chilled water leaving heat exchanger: ° C

Cabinet temperature in front of heat exchanger: ° C

Cabinet temperature behind of heat exchanger: ° C

Chilled water network bled: yes no

Pressure of chilled water network tested: yes no

(customer's protocol available)

Volume flow adjusted: yes no

external

Water flow: l / min external

Remarks:

.....

Correctness of above values is hereby confirmed.
Commissioning was performed during on-going operation.

yes no

.....
Commissioning firm

.....
Date

.....
Signature

.....
Customer

.....
Date

.....
Signature

9.4 Knürr DCD – performance charts

9.4.1 Performance diagrams

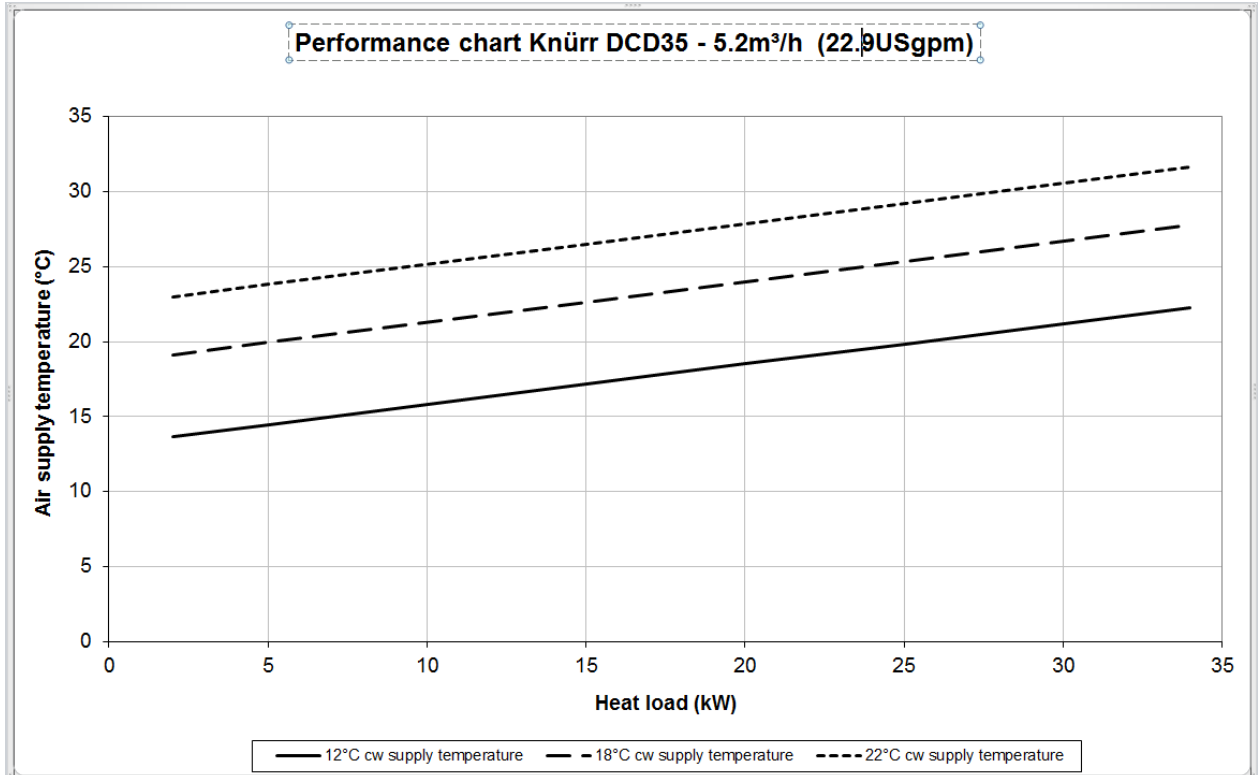

Figure 58 Performance chart Knürr DCD35 - 1

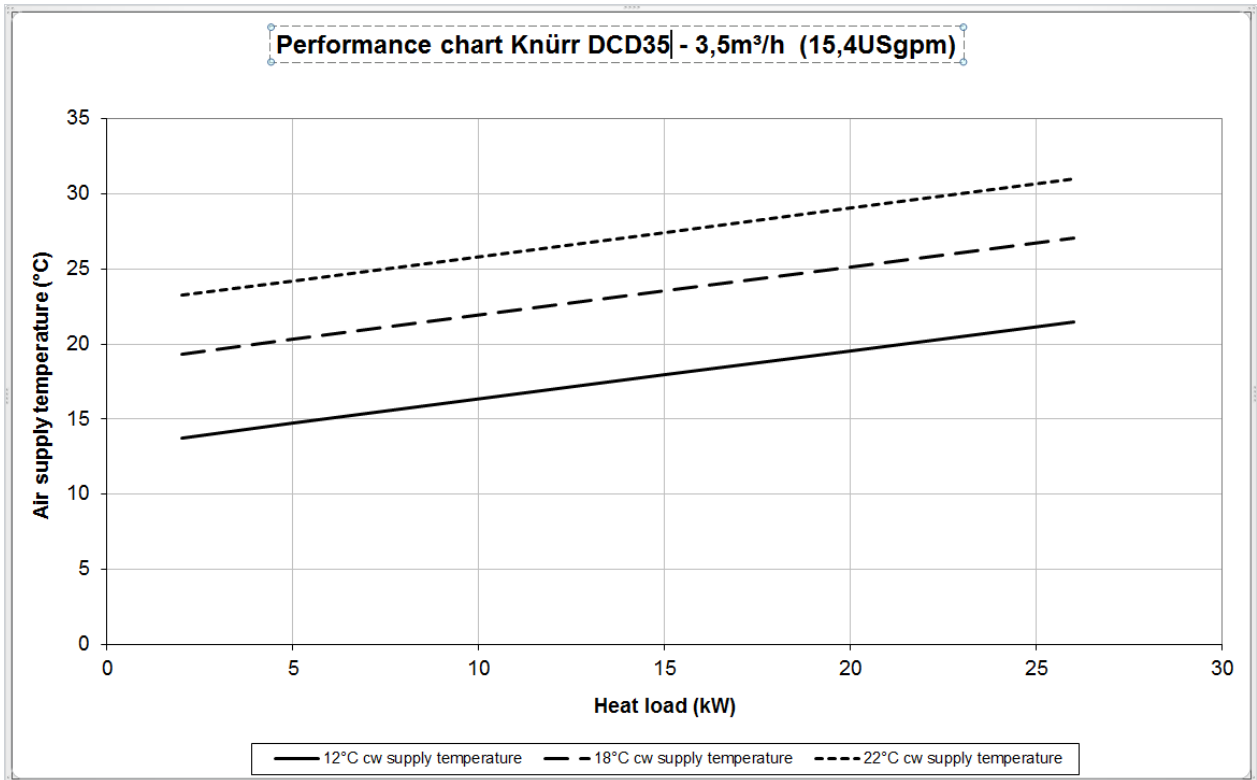

Figure 59 Performance chart Knürr DCD35 - 2

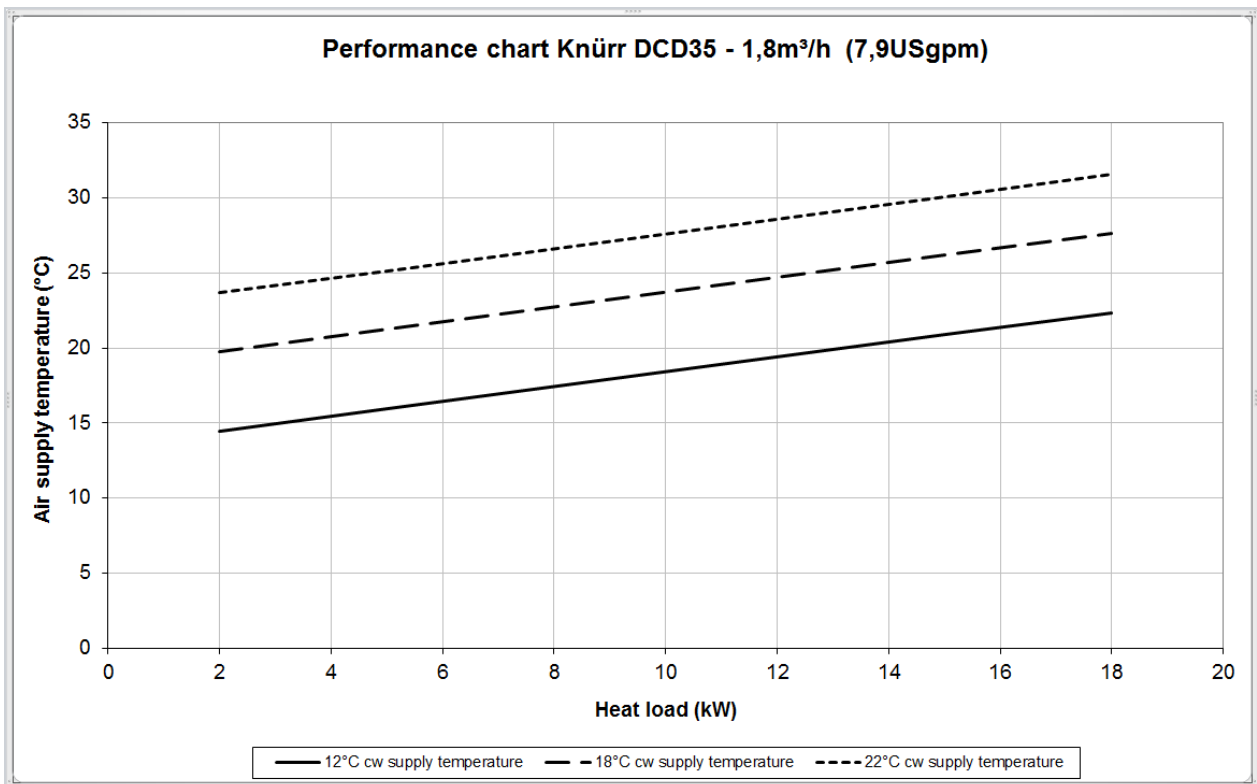

Figure 60 Performance chart Knürr DCD35 - 3

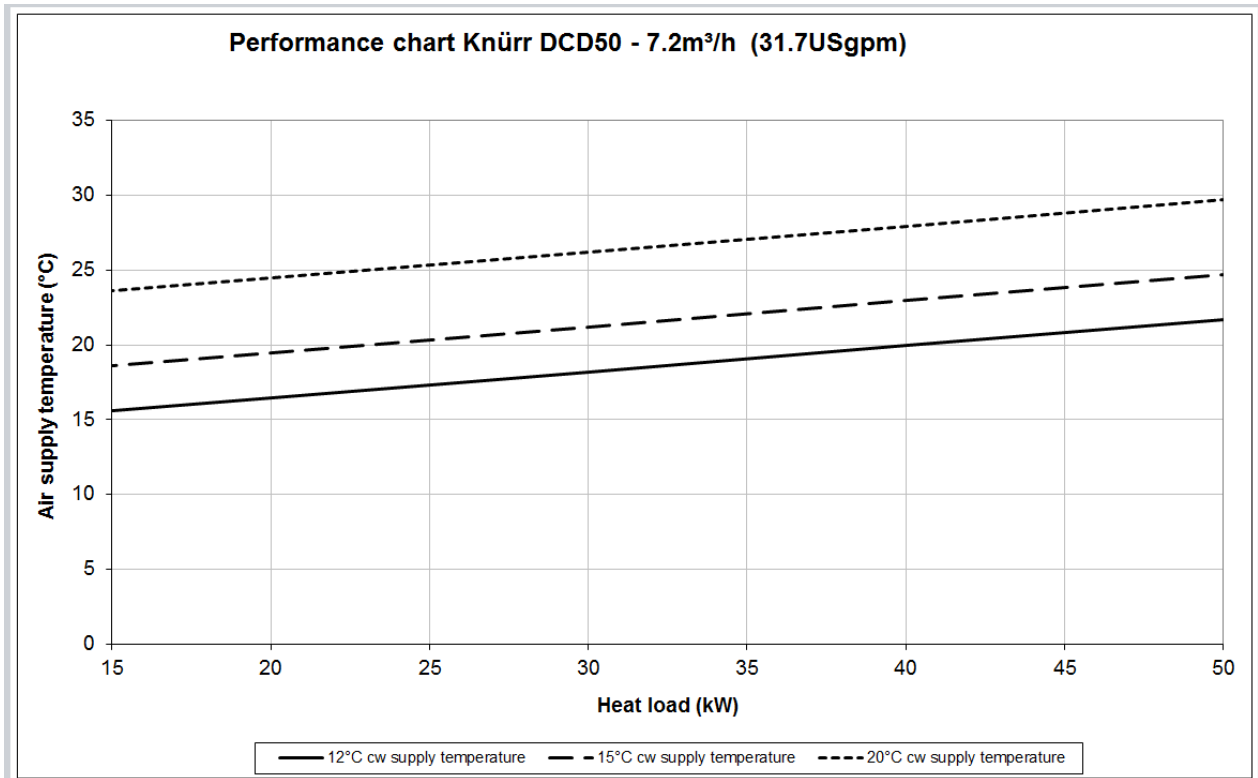

Figure 61 Performance chart Knürr DCD50 - 1

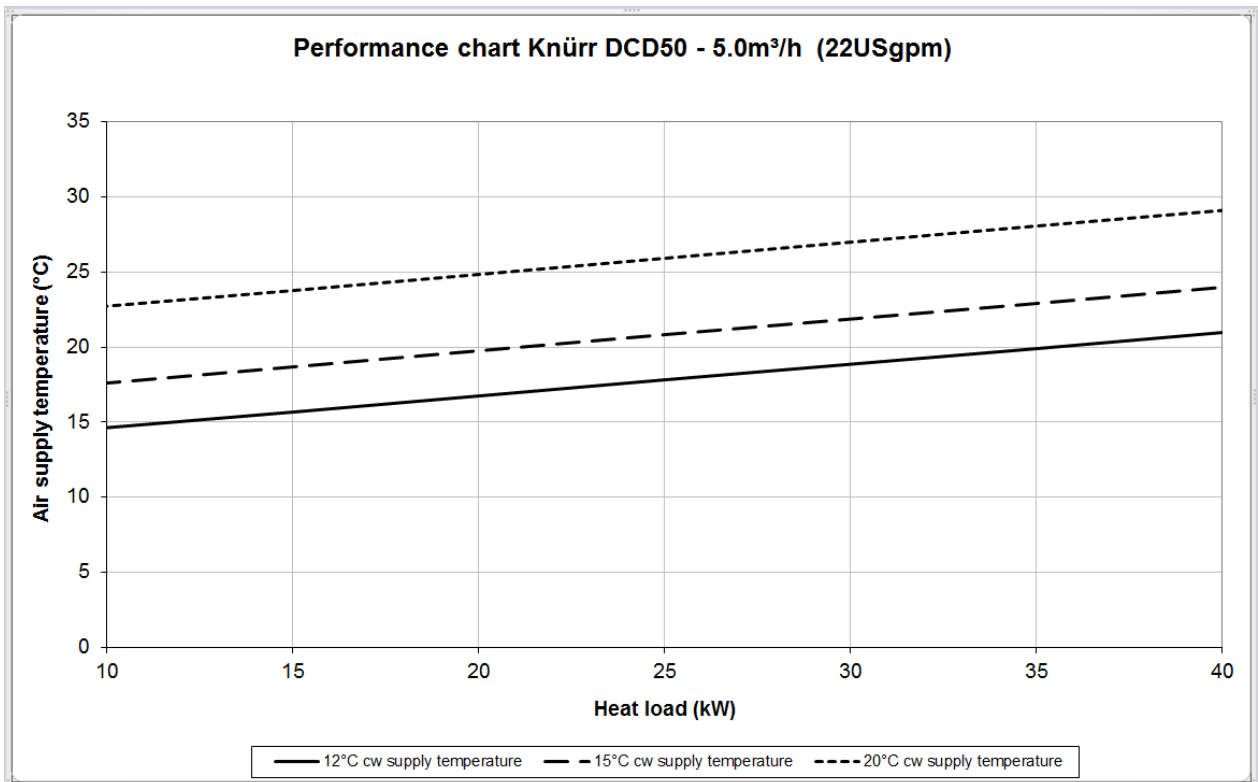

Figure 62 Performance chart Knürr DCD50 - 2

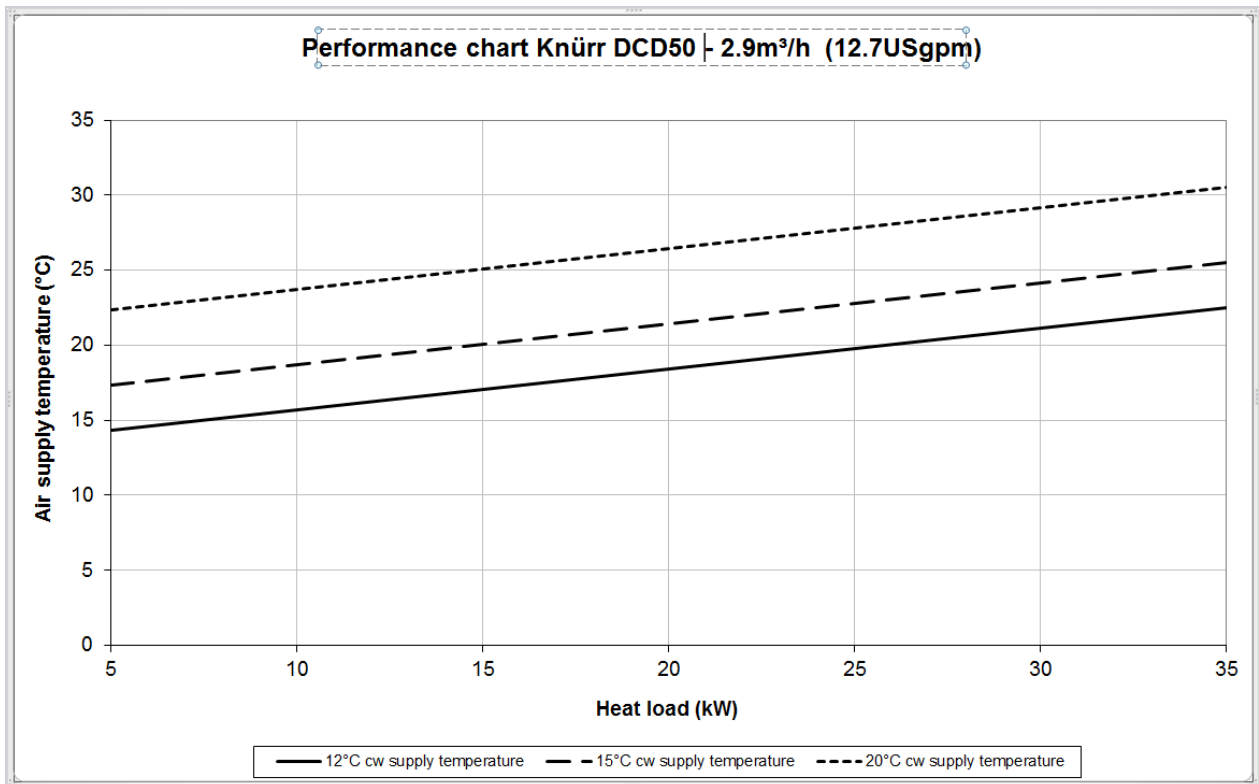

Figure 63 Performance chart Knürr DCD50 - 3

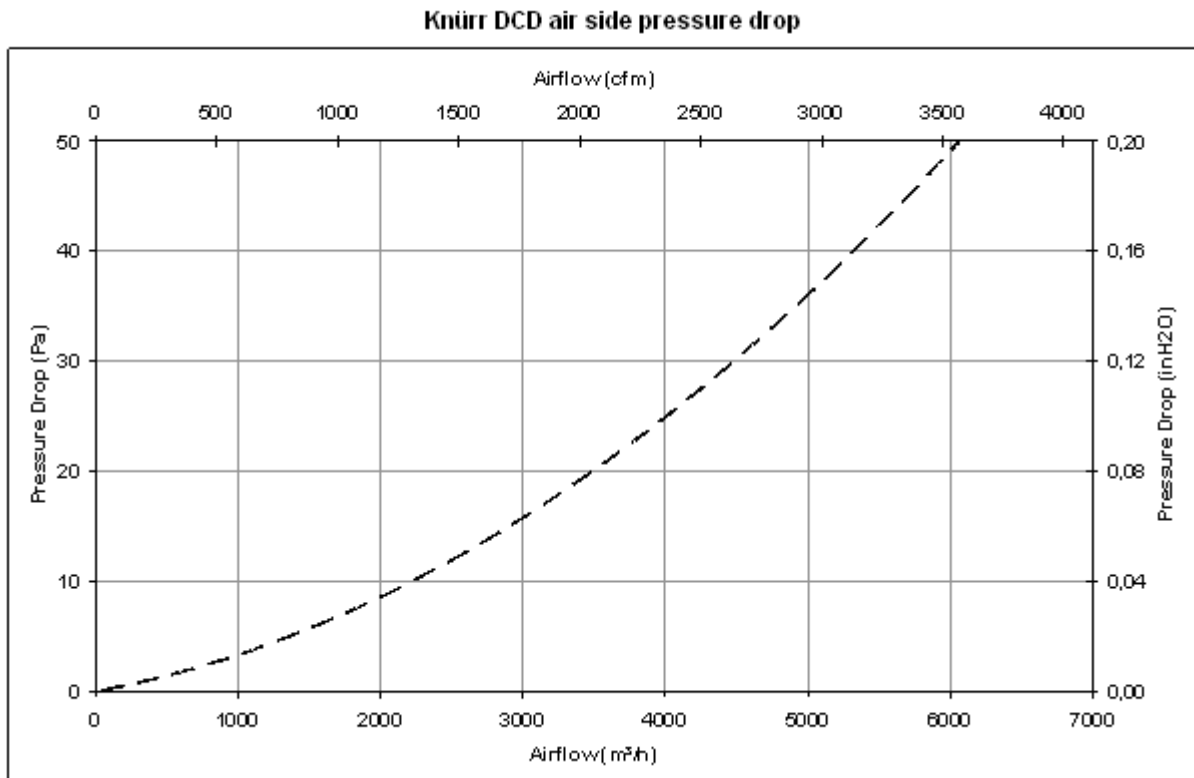

Figure 64 Cooling air pressure drop Knürr DCD35

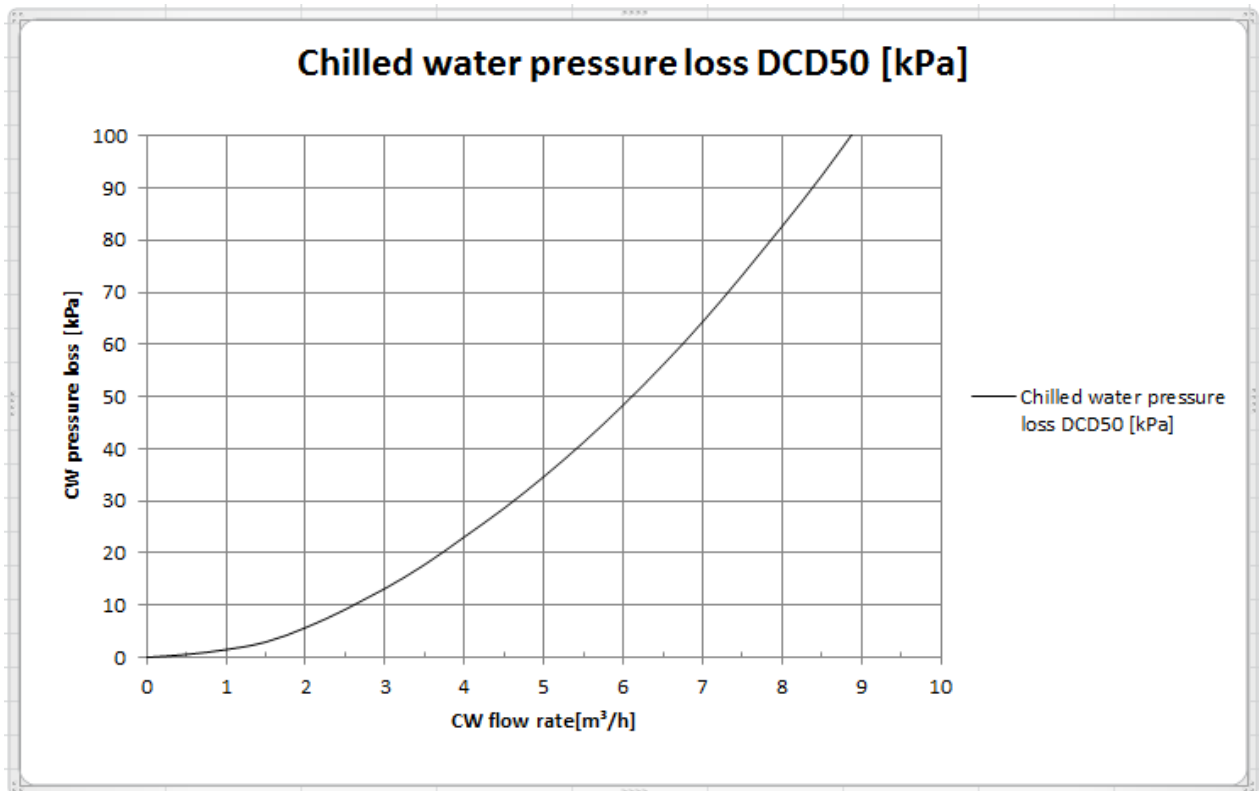

Figure 65 Cooling air pressure drop Knürr DCD50

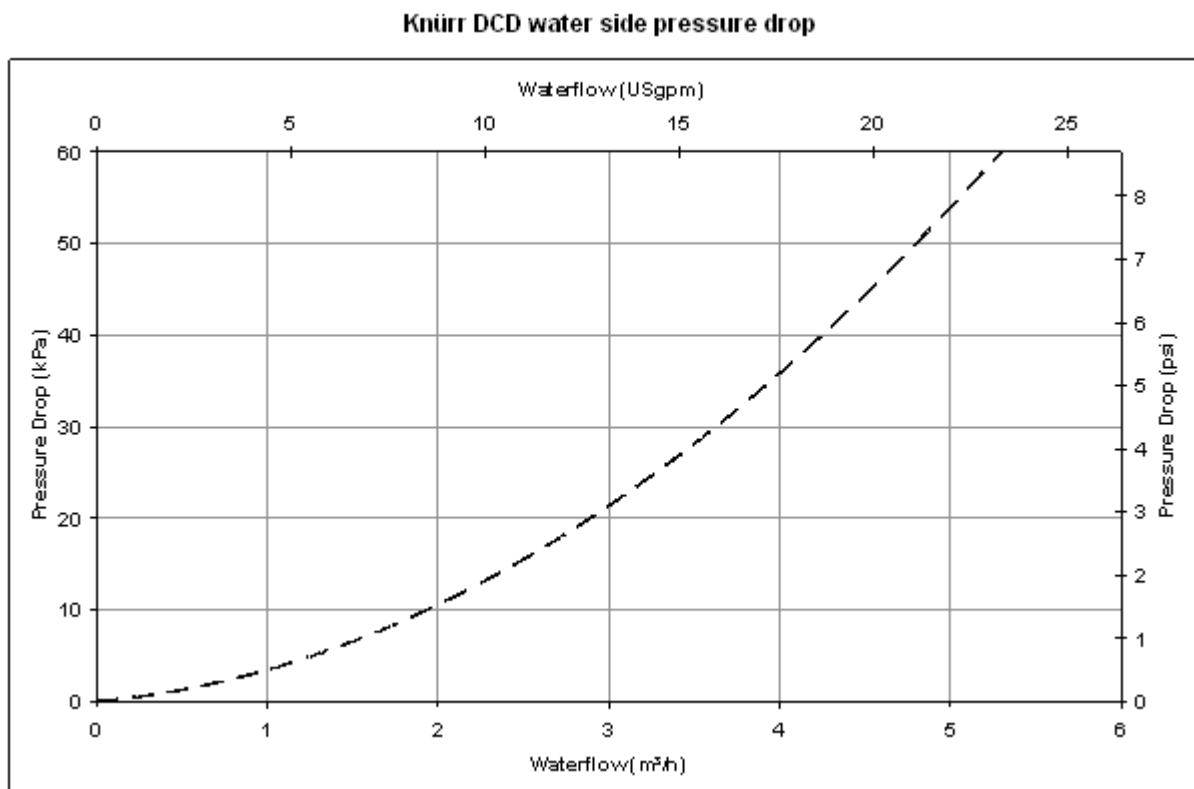

Figure 66 Chilled water pressure drop DCD35

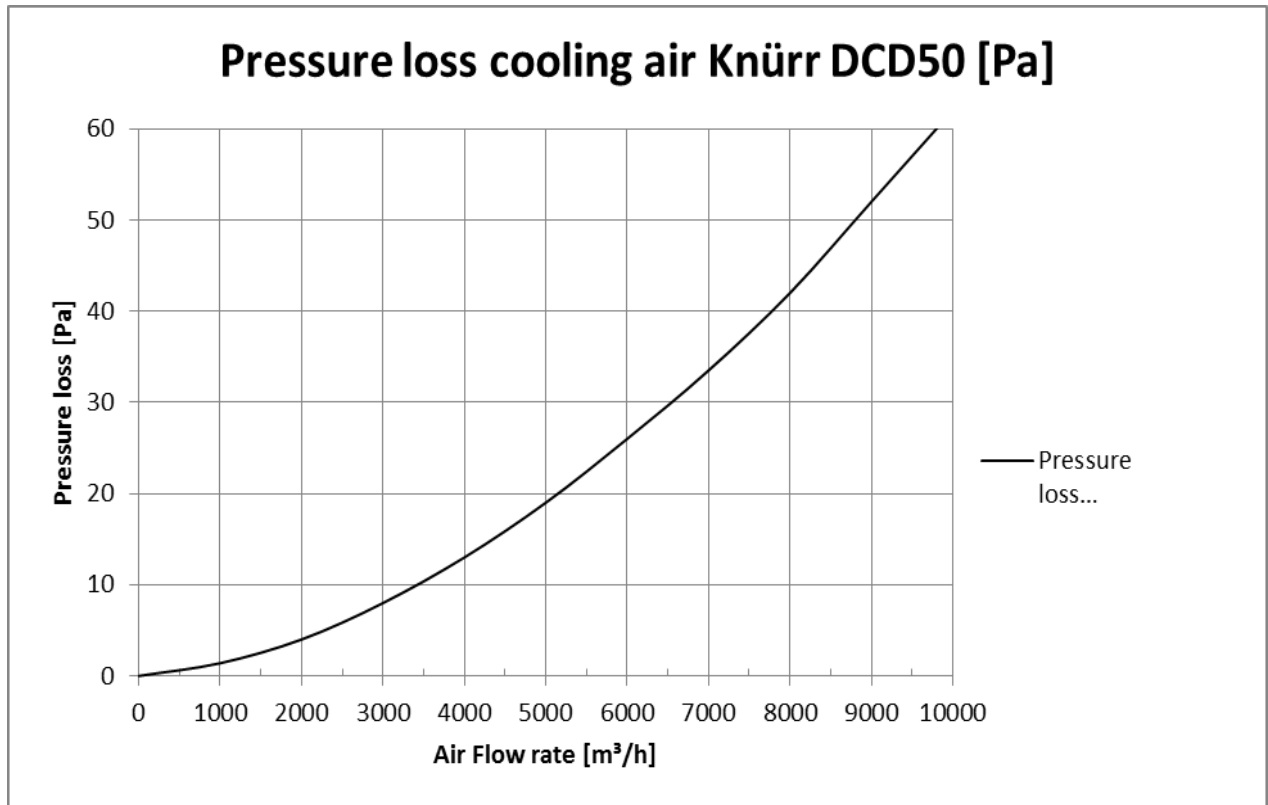

Figure 67 Chilled water pressure drop DCD50

9.5 Unit conversion chart

Unit conversion

1 mm 0.0394 in

1 kg 2.205 lbs

1 bar 14.504 psi

[°F] $([°C] \cdot 1.8) + 32$