

# **Liebert. PEX+ Series Precision Air Conditioner**

## **User Manual**

Version            V1.0

---

Emerson Network Power provides customers with technical support. Users may contact the nearest Emerson local sales office or service center.

Copyright © 2013 by Emerson Network Power Co., Ltd.

All rights reserved. The contents in this document are subject to change without notice.

Emerson Network Power Co., Ltd.

Address: No.1 Kefa Rd., Science & Industry Park, Nanshan District 518057, Shenzhen China

Homepage: [www.emersonnetworkpower.com.cn](http://www.emersonnetworkpower.com.cn)

Customer service hotline: 4008876510

E-mail: [support@emersonnetwork.com.cn](mailto:support@emersonnetwork.com.cn)



# Contents

Chapter 1 Overview .....	1
1.1 Model Description .....	1
1.2 Appearance .....	1
1.3 Main Components and Optional Features .....	2
1.3.1 Components of Indoor Unit.....	2
1.3.2 Condenser .....	3
1.3.3 Remote Monitoring Software .....	3
1.3.4 Optional Features .....	3
1.4 Transportation And Movement.....	3
1.5 Storage Environment .....	4
Chapter 2 Instructions for Installation Preparations.....	5
2.1 Equipment Room Requirement.....	5
2.2 Installation Space.....	5
2.2.1 Installation Space Requirements .....	5
2.2.2 Maintenance Space requirement.....	5
2.3 Operating Environment .....	6
2.4 Unpacking And Inspection .....	6
2.4.1 Unpacking.....	6
2.4.2 Inspection .....	7
Chapter 3 Mechanical Installation .....	8
3.1 Installation Notes .....	8
3.2 System Installation Arrangement .....	8
3.2.1 Overall System Arrangement.....	8
3.2.2 System Installation Illustration .....	9
3.3 Mechanical Parameters .....	9
3.3.1 Dimensions and weight of indoor unit.....	9
3.3.2 Dimensions and weight of condenser .....	10
3.3.3 Plenum dimensions (for upflow unit).....	10
3.3.4 Positions and dimensions of air outlet .....	11
3.4 Installing Indoor Unit .....	13
3.4.1 Making base .....	13
3.4.2 Installing base.....	13
3.4.3 Vibration absorbing.....	13
3.4.4 Install Indoor Unit Cabinet .....	14
3.5 Installing Condenser .....	14
3.6 Piping For Air-Cooled Unit .....	14
3.6.1 Pipe Extension Kit (Optional).....	14
3.6.2 Connecting condensate drain pipe of indoor unit.....	14
3.6.3 Connecting water inlet pipe of humidifier .....	15
3.6.4 Connecting copper pipes (discharge pipe and liquid pipe) between indoor unit and condenser.....	15
3.6.5 Installing pipe extension kit (optional, for site installation) .....	17

3.7 Lowering Fan (For Down Flow Unit) .....	17
3.8 Removing Fastener And Vibration Absorber.....	19
3.9 Installation Inspection .....	20
Chapter 4 Electrical Installation.....	21
4.1 Installation Notes .....	21
4.2 Wiring Of Indoor Unit .....	21
4.2.1 Locating Electrical Ports Of Indoor Unit.....	21
4.2.2 Connecting Power Cable Of Indoor Unit.....	21
4.2.3 Connecting Control Cables.....	22
4.2.4 Connecting Solenoid Valve Of Pipe Extension Kit (Options, For Site Installation).....	23
4.3 Wiring Of Condenser .....	23
4.3.1 Connecting Control Signal Terminals .....	23
4.3.2 Connecting Control Signal Cables.....	24
4.4 Installation Inspection .....	24
Chapter 5 Controller Operation Instructions.....	25
5.1 Appearance .....	25
5.2 Control Keys .....	25
5.3 Indicators .....	25
5.4 Control Interface .....	26
5.4.1 Main Interface.....	26
5.4.2 Shutdown Interface.....	26
5.4.3 Password Interface.....	27
5.5 Main Menu .....	27
5.6 Submenu .....	27
5.7 User Menu .....	28
5.7.1 User Menu Introduction .....	28
5.7.2 Alarm Menu .....	28
5.7.3 Set Point Control .....	30
5.7.4 Display Setting.....	30
5.7.5 Graph Menu.....	30
5.8 Professional Maintenance Menus.....	31
5.8.1 Professional Maintenance Menus Introduction .....	31
5.8.2 Alarm Menu .....	31
5.8.3 System Status .....	32
5.8.4 System Menu.....	33
5.8.5 Run Hours .....	37
5.8.6 On/Off Record .....	37
5.8.7 Manual Mode.....	38
5.8.8 Team Work .....	38
Chapter 6 System Operation And Maintenance.....	39
6.1 Monthly Routine Inspection Items.....	39
6.2 Routine Inspection Items (Half A Year).....	39
6.3 Self-diagnosis Function.....	40
6.4 Electrical Connection Inspection .....	40

6.5 Control Component Appearance Inspection .....	40
6.6 Air Cooled Condenser.....	41
6.7 Filter.....	41
6.8 Infrared Humidifier .....	42
6.9 Electric Heater .....	42
Chapter 7 Troubleshooting.....	43
7.1 Fan Troubleshooting.....	43
7.2 Infrared Humidifier Troubleshooting.....	43
7.3 Compressor and Cooling System Troubleshooting.....	43
7.4 Heating System Troubleshooting.....	44
Appendix 1 Circuit Diagram.....	45
Appendix 2 Menu Structure of PACC Controller (Standard Configuration) .....	47
Appendix 3 Alarm Control Menu Table.....	49
Appendix 4 Hazardous Substances or Elements Announcement.....	50
Appendix 5 Monthly Routine Inspection Items .....	51
Appendix 6 Routine Inspection Items (Half A Year) .....	52



## **Foreword**

---

*Liebert.PEX+ series product is the precision air conditioner used in data center, which is developed based on the Global R&D Platform of Emerson Network Power Co., Ltd. (“Emerson” for short hereafter)*

*This manual focuses on the using instructions, including instructions for installation preparations, mechanical installation, electrical installation, controller operation, system operation and maintenance, and troubleshooting, etc. The system operation and maintenance, trouble-shooting and handling are only limited to user’s independent maintenance. For the maintenance and troubleshooting works not mentioned in this manual, please contact Emerson professional engineer. The commissioning and startup will be conducted by Emerson engineer, so this part is not described in this manual.*

*Please read this manual carefully before installing, maintaining and troubleshooting, especially the warning information in the manual.*

---





# Chapter 1 Overview

The Liebert.PEX+ series precision air conditioner (“Liebert.PEX+” for short hereafter) is professional equipment, which should not be accessible to the general public. The Liebert.PEX+ is a medium-large size precision environment control system, suitable for the environment control of the equipment room or computer room, featuring high reliability, high sensible heat ratio and large air flow. This chapter introduces the model description, appearance, main components and optional parts.

## 1.1 Model Description

The model description of Liebert.PEX+ is shown in Figure 1-1.

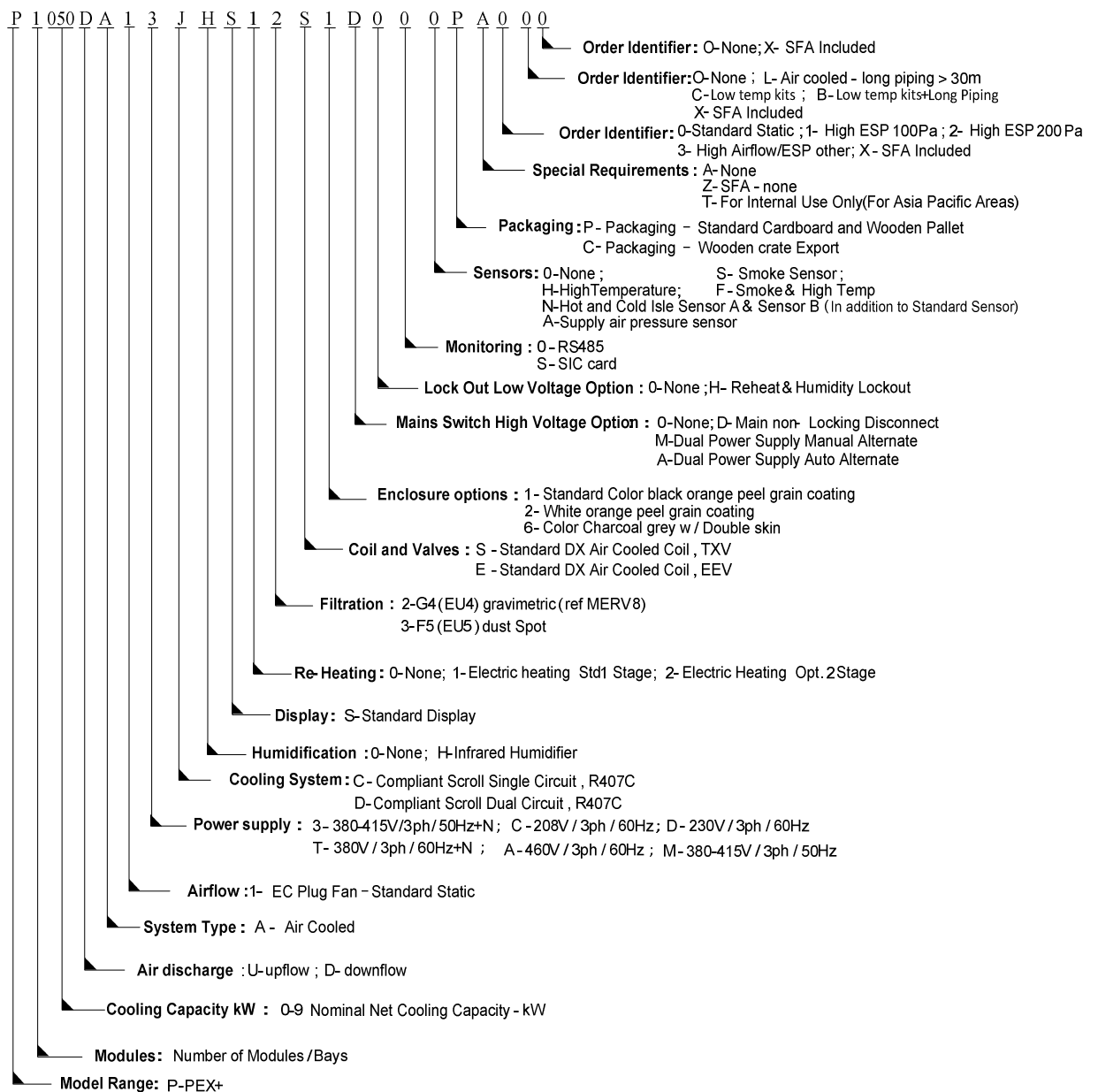

Figure 1-1 Model description

## 1.2 Appearance

Liebert.PEX+ appearance is shown in Figure 1-2 with P3080UA as an example.



Figure 1-2 Appearance

### 1.3 Main Components and Optional Features

The components include indoor unit, condenser and remote monitoring software.

#### 1.3.1 Components of Indoor Unit

The indoor unit includes compressor, evaporator, thermal expansion valve, infrared humidifier, DC speed-regulated centrifugal fan (“EC fan” for short hereafter), electric heater, sight glass, filter drier and PACC (Precision Air-Conditioner controller) controller. The descriptions of the components are given in Table 1-1.

Table 1-1 Descriptions of main components of indoor unit

Components	Descriptions
Compressor	<ul style="list-style-type: none"> <li>Highly effective Copeland scroll compressor is used, featuring low vibration, low noise and high reliability.</li> <li>The Rotalock (screw thread) connection mode makes the maintenance easier.</li> </ul>
Evaporator	<ul style="list-style-type: none"> <li>Adopt a fin-tube heat exchanger with high efficiency.</li> <li>The distributor is designed and verified according to individual model to ensure that the refrigerant is distributed evenly in each loop, improving the heat exchanger efficiency to a great extent.</li> </ul>
Thermal expansion valve	<ul style="list-style-type: none"> <li>Adopt a thermal expansion valve with external equalizer type. It collects temperature and pressure signals at the same time to accurately regulate the refrigerant flow.</li> </ul>
Infrared humidifier	<ul style="list-style-type: none"> <li>The infrared humidifier has a simple structure, which is easy for teardown, cleaning and maintenance.</li> <li>Application of the infrared humidifier can reduce the dependence on water quality. It also features fast startup, short humidifying time, large humidifying capacity and high humidifying efficiency.</li> </ul>
Fan	<ul style="list-style-type: none"> <li>PEX+ series use the EC fan, which features high efficiency, energy-saving, space-saving and low noise.</li> <li>EC fan unit uses elaborate structure design, and the downflow unit uses the ‘in-floor’ design, which positions the fan unit below the floor to further improve the efficiency of air supply.</li> </ul>
Electric heater	<ul style="list-style-type: none"> <li>The electric metal heater is used. It features fast heating speed and even heat and high reliability.</li> </ul>
Sight glass	<ul style="list-style-type: none"> <li>The sight glass is the window of the system cycle, for observing the refrigerant state, mainly the moisture content of the system. When the moisture content exceeds the standard, the color will be changed.</li> </ul>
PACC Controller	<ul style="list-style-type: none"> <li>Emerson Micro-processing controller with advanced PID regulation technology.</li> <li>LCD screen with blue backlight and 240 × 128 dot-matrix, simple user interface operation.</li> <li>The multi-level password protection can effectively prevent unauthorized operation.</li> <li>Self-recovery upon power failure, high-voltage &amp; low-voltage protection.</li> <li>The operation time of main components is available through the menus.</li> <li>The expert-level fault diagnosis system can display the current fault information automatically, facilitating the maintenance.</li> <li>It can store up to 200 records of history events. Configured with the RS485 port and standard communication protocol of Ministry of Information Enterprise.</li> </ul>
Filter drier	<ul style="list-style-type: none"> <li>The filter drier eliminates the moisture effectively in the system, and also filtrates the impurities generated during the long-term system operation so as to ensure normal system operation.</li> </ul>

### 1.3.2 Condenser

Refer to condenser user manual.

### 1.3.3 Remote Monitoring Software

Liebert.PEX+ uses the standard communication protocol defined by Ministry of Information Enterprise. Refer to *section 3 Intelligent device protocol, Power Supply, Air Conditioner and Environmental Centralized Monitoring System* for details. Through the configured RS485 or TCP/IP port, Liebert.PEX+ can communicate with the host computer and receive the control of the host software.

### 1.3.4 Optional Features

The optional parts include: Extension kit, low temperature kit, two-level electric heater, no heater, no humidifier, plenum for upflow unit, electrode humidifier, water cooled unit and electronic expansion valve.

#### **Extension kit**

If there is a requirement for long piping / high vertical drop between the indoor unit and condenser according to actual application condition, an extension kit shall be configured and the specific selection is described in 3.6.1 Pipe Extension Kit (Optional) .

#### **Low temperature kit**

In winter (outdoor temperature below  $-15^{\circ}\text{C}$ ), the air conditioner shall use a low temperature kit for cooling. This kit is inside the unit. User should consider the low temperature environment to make reasonable selection.

#### **Two-stage electric heater**

According to user requirement, a two-stage electric heater shall be used and the heating capacity shall be identical with the one-stage heater

#### **No heater**

Liebert.PEX+ AC shall have the option without heating according to user requirements.

#### **No humidifier**

Liebert.PEX+ AC shall have the option without humidifying according to user requirements.

#### **Plenum**

The upflow unit shall be configured with a plenum with its configuration listed in 3.3.3 *Plenum* dimensions (for upflow unit). For special plenum, please contact Emerson.

#### **Electrode humidifier**

Liebert.PEX+ AC shall have the option of electrode humidifier according to user requirements. The electrode humidifier has a different requirement for water inlet / outlet pipes with the standard infrared humidifier. Refer to 3.6.3 Connecting water inlet pipe of humidifier for the configurations of water inlet/outlet pipes of electrode humidifier.

#### **Water cooled unit**

Non-standard water-cooled unit can be designed according to user requirements. The corresponding water inlet / outlet pipes shall be configured for installation and the pipes shall connect to chilled water on user site. If the pipe is below DN40, we recommend using threaded connection of galvanized pipe. When the pipe exceeds DN50, use welded connection of seamless steel tubes. For the convenience of using and maintenance from user side to unit, we recommend that users configure check valve, filter, thermometer, pressure gauge, sewage pipe and vibration-absorbing joints; The cleanliness of water system must be detected before running the water system to avoid affecting air conditioning system by sewage.

#### **Electronic expansion valve**

The standard configuration is mechanical type thermal expansion valve, and optional electronic expansion valve can be provided according to user requirements.

## 1.4 Transportation And Movement

Railroad transportation and shipping are recommended for transportation. If truck transportation is unavoidable, choose roads that are less bumpy in order to protect the equipment. It is recommended to use mechanical equipment

such as an electric forklift to unload and move the equipment. If an electric forklift is used, insert the tines of the forklift below the pallet, as shown in Figure 1-3 to prevent the equipment from falling over. When moving the indoor unit, keep the obliquity within the range from 75° to 105°, proper incline, as shown in Figure 1-4.



Figure 1-3 Inserting and movement

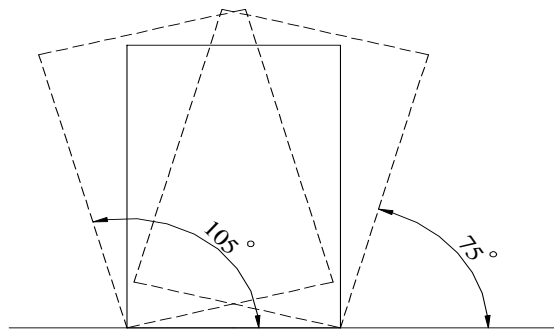

Figure 1-4 Moving obliquity

## 1.5 Storage Environment

The storage environment of Liebert.PEX+ meets the requirements of GB4798.1-2005. See Table 1-2 for details.

Table 1-2 Storage environment requirement

Item	Requirement
General requirements	Indoor, clean, no dust
Ambient humidity	5%RH to 85%RH (non-condensing)
Ambient temperature	-20°C to +54°C
Storage time	Total transportation and storage time should not exceed six months. Otherwise, the performance needs to be re-calibrated

## Chapter 2 Instructions for Installation Preparations

Liebert.PEX+ is professional equipment, and there are lots of complex installation works, so the preparation is very important. This chapter details the installation preparation, including how to prepare the installation environment and space and reserve the maintenance space, and how to unpack and inspect. Please read this chapter carefully before installation.

### 2.1 Equipment Room Requirement

The requirements are as follows:

1. The equipment room should have good heat insulation.
2. The equipment room should have sealed damp proof layer. The damp proof layer of the ceiling and walls must use polyethylene film or be applied with moisture proof paint. The coating of the concrete wall and the floor must be damp proof.
3. All the doors and windows should be closed and the seams (if any) should be as narrow as possible to prevent the outdoor air from entering the equipment room, which may increase the load of heating, cooling, humidifying and dehumidification of the system. It is recommended that the inhalation of outdoor air be kept below 5% of the total indoor airflow.

### 2.2 Installation Space

#### 2.2.1 Installation Space Requirements

Adequate installation space for the indoor unit must be provided. The indoor unit of air cooled product must be installed on the floor of equipment room or computer room, and the condenser can be installed on the ground of outdoor or other room. The entire water cooled precision AC shall be installed on floor of equipment room or computer room.

#### warning

- Do not use the indoor unit in the open and severe outdoor environment.
- Avoid locating the indoor unit in concave or narrow areas, which can baffle the airflow, shorten the cooling cycle and result in air return short circuit and air noise.
- Avoid locating multiple indoor units close to each other. That can result in crossing air patterns, unbalanced load and competitive operation.
- Do not install the unit in the vicinity of any precision equipment, and prevent the leaked condensation water due to improper use of the air conditioner from affecting the operation of precision equipment.
- Do not install other devices (such as smoke detector) over the cabinet.

#### 2.2.2 Maintenance Space requirement

Be sure to reserve maintenance space when installing the equipment. Leave a maintenance space of 850mm in front of the air conditioner unit normally, and the minimal maintenance space is not less than 600mm. The requirement for maintenance space is given in Figure 2-1.

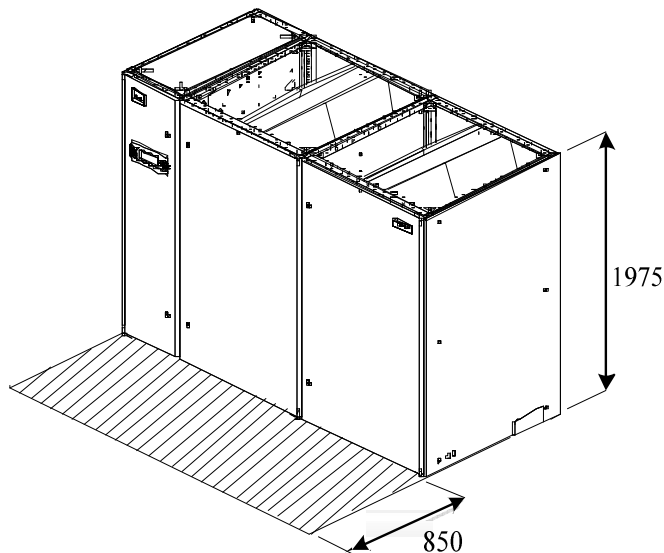

Figure 2-1 Maintenance space of unit

## 2.3 Operating Environment

The operation environment of Liebert.PEX+ meets the requirements of GB4798.3-2007. See Table 2-1 for details.

Table 2-1 Operating environment requirement

Item	Requirement	
Ambient temperature	Indoor	0°C ~ 40°C, the unit should not run in 32~40°C environment for a long time.
	Outdoor	Water-cooled: 4°C ~ 45°C ; air-cooled: -34°C ~ +45°C
Protection level (indoor unit)	IP20	
Altitude	<1000m. Above that, derating is required	
Operation voltage range	380V (-10% ~ +15%), 3N~ 50Hz	



**Note**

When the unit is used in the following condition, please contact Emerson:

- If the unit voltage exceeds the operating voltage range.
- Derating for altitude above 1000m.
- Other applications outside of applicable scopes.

## 2.4 Unpacking And Inspection

### 2.4.1 Unpacking

**Remove external package**

First, remove the packaging belt and carton, then the top cover, the sealing plastic film and finally the honeycomb paper board, as shown in Figure 2-2.

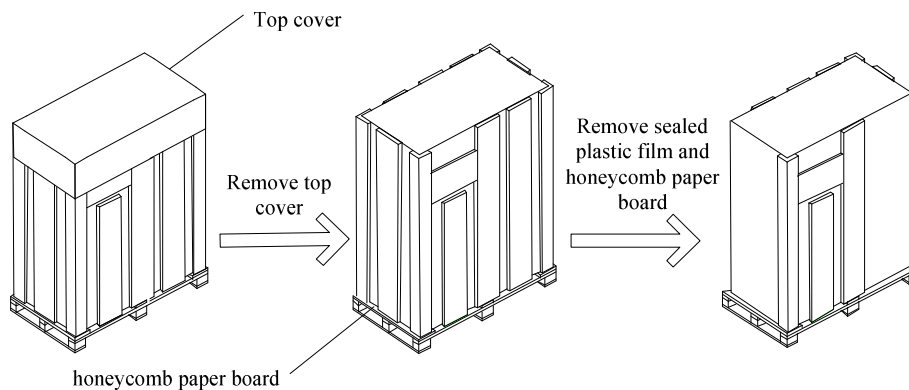

Figure 2-2 Remove external package

### Remove the base pallet

The unit is fixed onto the base pallet with  $8 \times 70$  screw, as shown in Figure 2-3. You can use a 17mm open-end spanner, ratchet spanner or sleeve to remove the fixing screw.

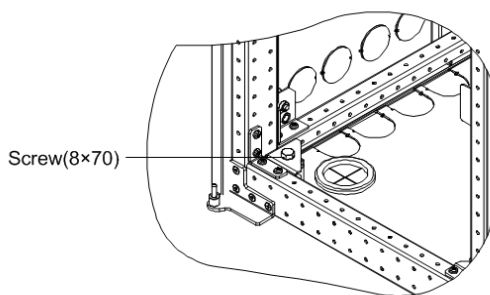

Figure 2-3 Positions of wooden screws

### 2.4.2 Inspection

Check against the *Packing List* that the fittings are complete and the components are intact. If any parts are found missing, or damaged, please report to the carrier immediately. If any hidden damages are found, please report to the local offices of the carrier and Emerson.

## Chapter 3 Mechanical Installation

To achieve the designed performance and maximize the product life, correct installation is vital. This chapter introduces the installation notes, installation layout, installation procedures, piping and fan lowering operations.

### 3.1 Installation Notes

1. Prior to installation, be sure to read the whole contents of *Chapter 2 Instructions* for Installation Preparations, and confirm that the installation positions have been confirmed according to the requirements of 2.2 .
2. Liebert.PEX+ air-cooled series air conditioner is designed for split floor installation. The indoor unit must be installed on the floor of the equipment room or computer room, and the condenser can be installed outdoors or on the floor of other rooms. The Liebert.PEX+ water-cooled air conditioner is designed for integrated floor installation. It should be installed on the floor of the equipment room or computer room.
3. The selection, layout and fixing of the pipes shall comply with industrial standard.
4. Pressure drop, compressor oil return, noise reduction and vibration shall be considered in design and installation.
5. The unit shall be fixed by screws and mounting rails to avoid shaking during startup or operating processes.

### 3.2 System Installation Arrangement

#### 3.2.1 Overall System Arrangement

The overall arrangement of Liebert.PEX+ series air conditioner is shown in Figure 3-1.

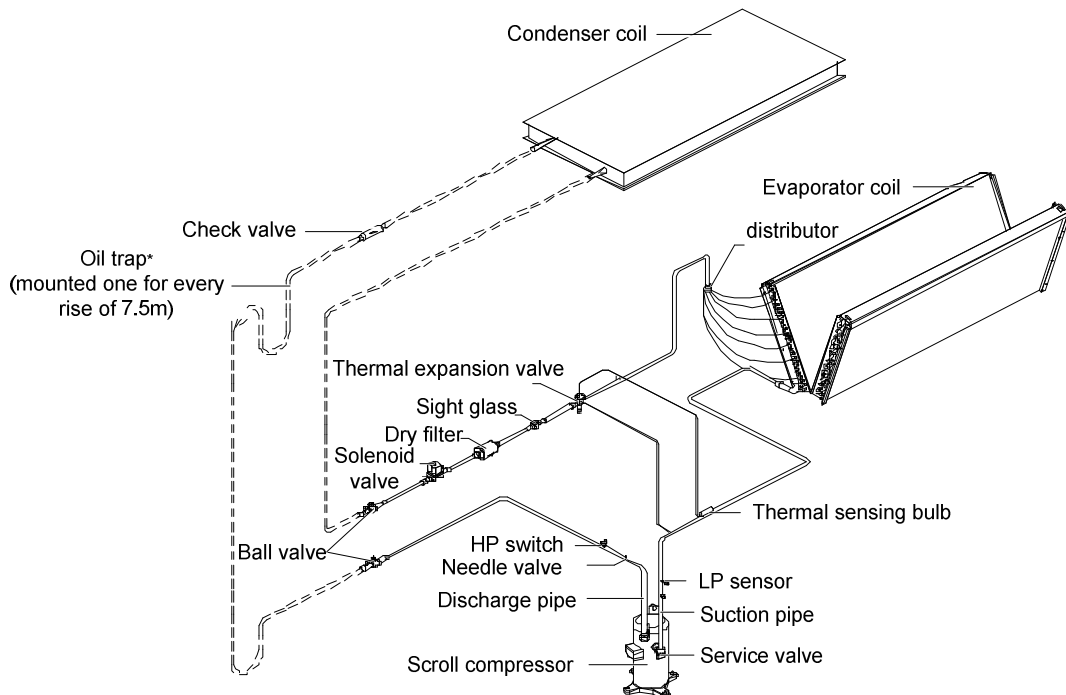

Figure 3-1 Overall system arrangement

Note:

1. The single system is used as an example to describe the double system.
2. —————: Emerson piping.
3. - - - - -: Field piping (by technicians).
4. \*: Components are not supplied by Emerson but are recommended for proper circuit operation and maintenance.
5. +: Components are required when the equivalent length exceeds 30m.



### 3.2.2 System Installation Illustration

The installation modes of the unit are shown in Figure 3-2 and Figure 3-3.

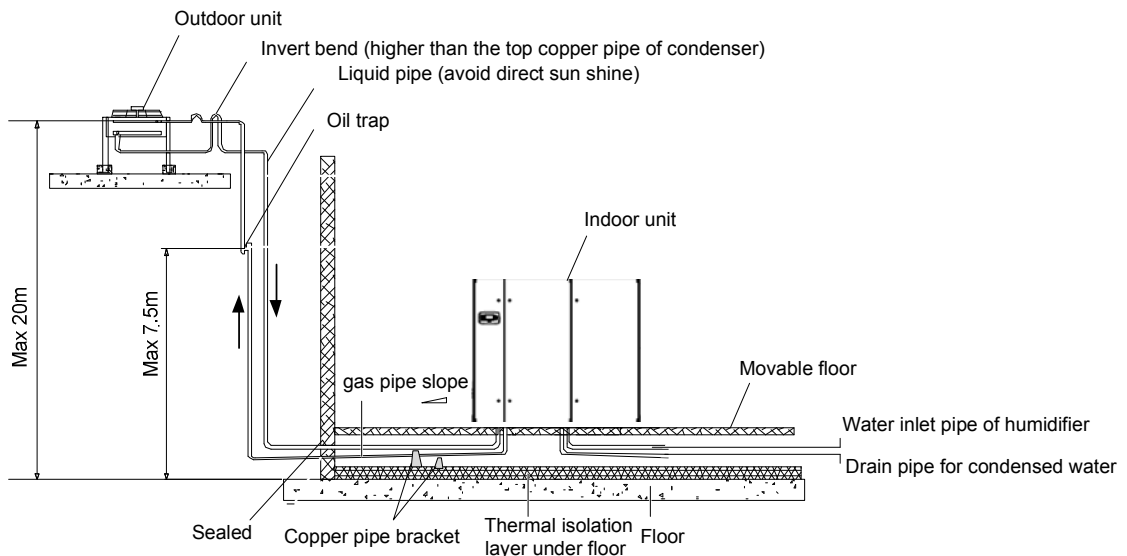

Figure 3-2 Condenser installed higher than compressor

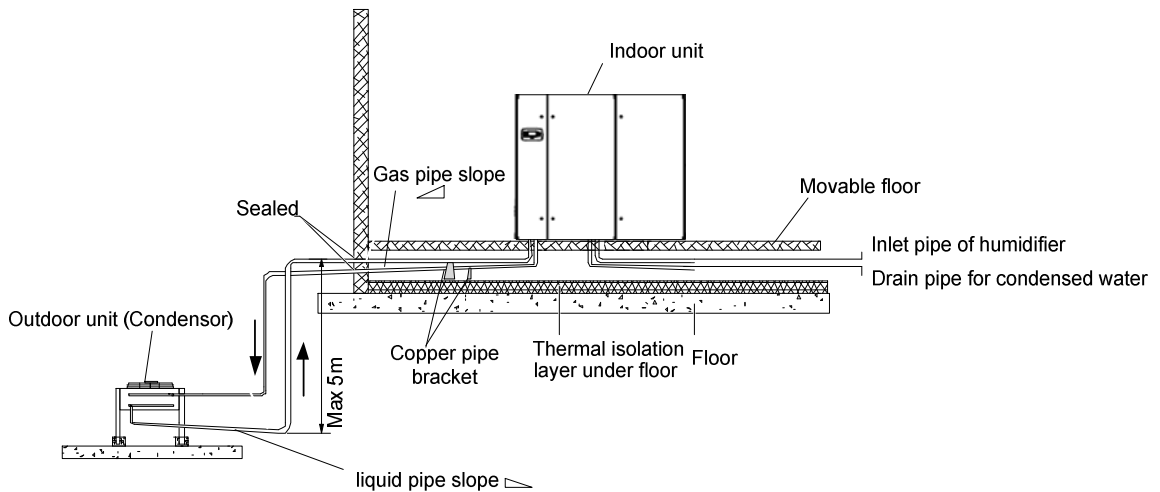

Figure 3-3 Condenser installed lower than compressor

#### Note

- If the condenser is installed higher than the compressor (see Figure 3-2), a back bend should be fitted to the discharge line and liquid line of the condenser, so as to prevent the liquid refrigerant from flowing back when the condenser stops.
- The top end of the back bend must be installed higher than the highest copper pipe of the condenser.

## 3.3 Mechanical Parameters

### 3.3.1 Dimensions and weight of indoor unit

The dimensions and weight of the indoor unit are shown in Figure 3-4, Figure 3-5 and Table 3-1.

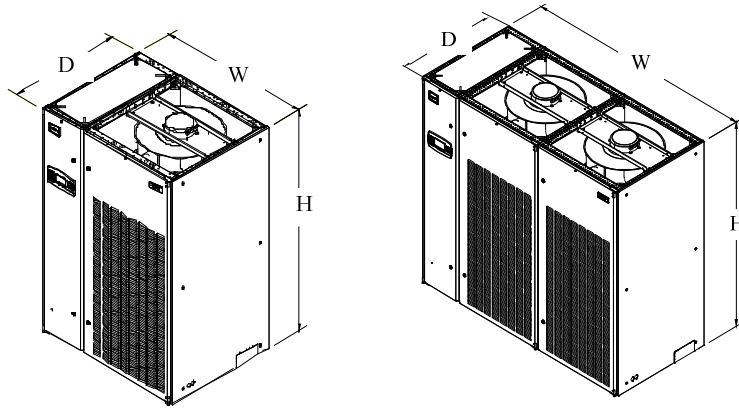

Figure 3-4 Outline drawings of the upflow indoor unit (unit: mm)

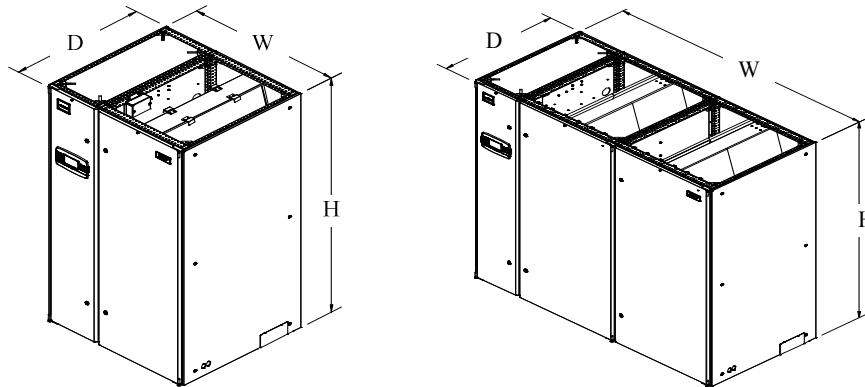

Figure 3-5 Outline drawings of the down flow indoor unit

Table 3-1 Dimensions and weight of indoor unit

Model	Dimensions (W×D×H)(mm)	Net weight (kg)
P1020U(D)A13C	853×874×1970	320
P1025U(D)A13C	853×874×1970	340
P1030U(D)A13C	1130×995×1975	436
P 1035U(D)A13C	1130×995×1975	440
P 1035U(D)A13S	1130×995×1975	460
P 1040U(D)A13C	1330×995×1975	470
P 1040U(D)A13S	1330×995×1975	480
P 1045U(D)A13C	1330×995×1975	530
P 1050U(D)A13C	1330×995×1975	535
P 1050U(D)A13S	1330×995×1975	570
P 2060U(D)A13S	1830×995×1975	690
P 2070U(D)A13S	1830×995×1975	730
P 3080U(D)A13S	2230×995×1975	770
P 3090U(D)A13S	2230×995×1975	808
P 3100U(D)A13S	2230×995×1975	810

### 3.3.2 Dimensions and weight of condenser

Refer to condenser user manual for the condenser dimensions and weight.

### 3.3.3 Plenum dimensions (for upflow unit)

The dimensions of plenum are shown in Table 3-2.

Table 3-2 Plenum dimensions (unit: mm)

Model	D(Depth)	W(Width)	H(Height)
P1020~1025	857	863	400 (600 optional)

Model	D(Depth)	W(Width)	H(Height)
P1030 to P1035	965	730	400(600, optional)
P1040 to P1050	965	930	400(600, optional)
P2060 to P2070	965	1430	400(600, optional)
P3080 to P3100	965	1830	400(600, optional)

Note

- If the height of the plenum selected for air conditioner unit exceeds 600mm, consult Emerson for non-standard production.

### 3.3.4 Positions and dimensions of air outlet

#### Base pallet cut-out location dimensions

The cutout position and dimensions are shown in Figure 3-6.

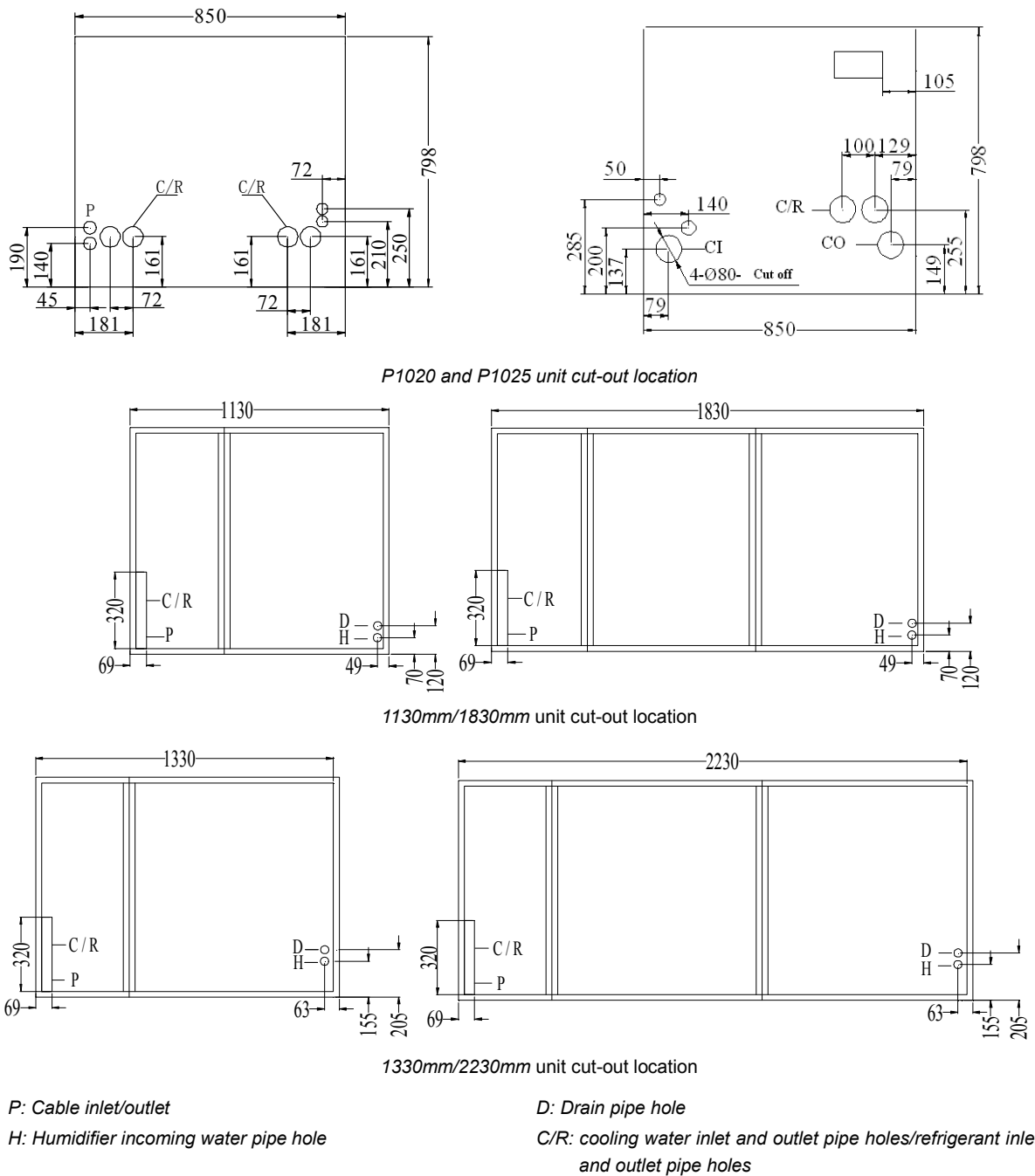

Figure 3-6 Base pallet cut-out locations of upflow series (unit: mm)

**Position and dimensions of air outlet on top cover**

The position and dimensions of air outlet on top cover of upflow unit are shown in Figure 3-7 and Table 3-3.

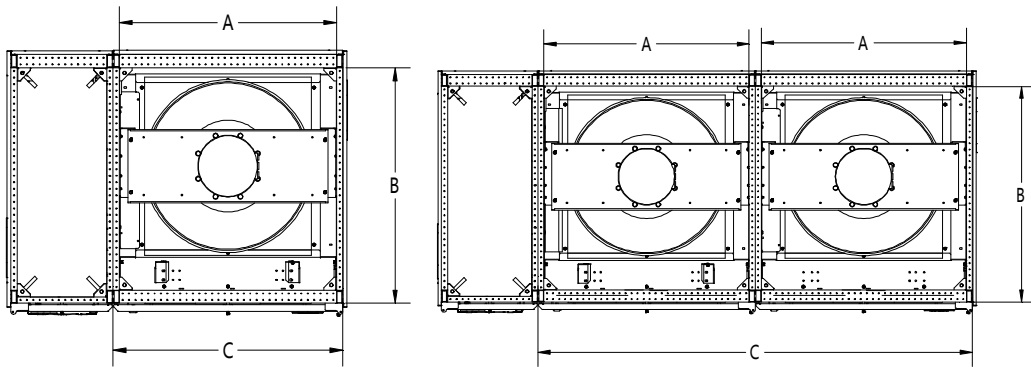

Figure 3-7 Position of air outlet on top cover of upflow unit

Table 3-3 Dimensions of air outlet on top cover of upflow unit (unit:mm)

Model	A	B	C
P1020~P1025	720	795	800
P1030~P1035	650	900	700
P1040~P1050	850	900	900
P2060~P2070	650	900	1400
P3080~P3100	850	900	1800

**Side panel knock-out locations**

If piping and wiring from the base are difficult, connection from side panel can be selected. The locations and dimensions of knock-out holes are shown in Figure 3-8. You should select the inlet and outlet holes according to the actual needs. Ensure only one service is used per opening.

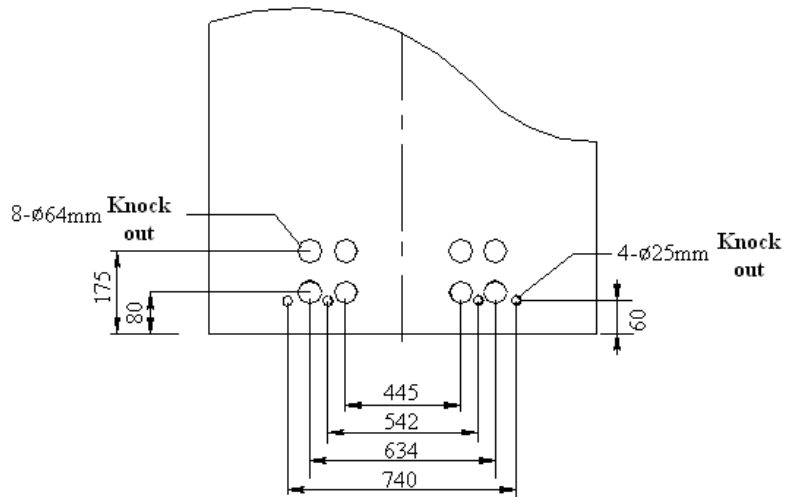

P1020 and P1025 series knock-out

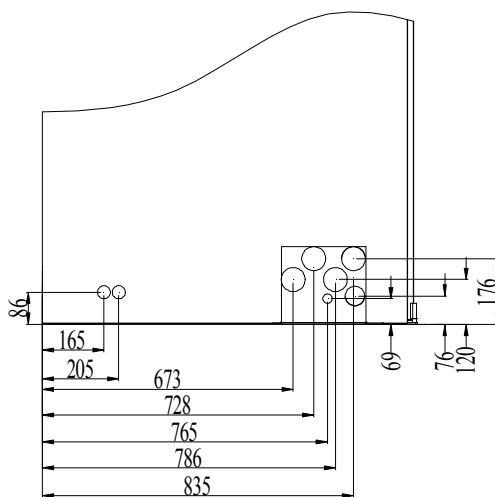

P1030-3100 series knock-out

Figure 3-8 Knock-out holes of side panel (unit: mm)

 Note

- The equipment has knock-outs, be sure to mount sleeve to the cable holes to avoid cutting the cables.

### 3.4 Installing Indoor Unit

#### 3.4.1 Making base

The base shall be made by the installation team according to the dimensions, weight and height of the unit to ensure the rigidity of the structure meets the requirement. User can make the base by himself or ask Emerson to make it.

 Note

- For the downflow unit, the base height must be higher than 450mm.
- The external side boards of the unit cannot bear weight.
- The distance between the object that may block the air flow at the top of the base and the outer edge of the EC fan shall be bigger than 160mm.

#### 3.4.2 Installing base

Determine the installation position according to the requirements of 2.2 manual, and fix the base onto the selected mounting position. The base shall be fixed to the ground through expansion bolts or spot welding, and the base shall be calibrated by horizontal ruler before it is fixed, so as to ensure the leveling top surface of the base. For downflow unit that requires the EC fan to be lowered, we must consider the spatial distance and the strength of the base in the design and installation of the base.

#### 3.4.3 Vibration absorbing

Lay a layer of rubber cushion on the top, lateral of the base and on the bottom of the steel plate respectively so as to avoid transmission of vibration during operation of the unit, see Table 3-4 for details.

Table 3-4 Dimensions of rubber cushion for vibration absorbing (unit: mm)

Item		Specification
Rubber cushion	Top	Thickness:3mm to 5mm
	Lateral	Thickness:2mm to 3mm
	Bottom	Thickness:10mm to 12mm

### 3.4.4 Install Indoor Unit Cabinet

The indoor unit cabinet should be installed on the base horizontal plane, and keep the unit after installation in the same horizontal plane, between the indoor unit and the base does not require welding or other rigid connections fixed

## 3.5 Installing Condenser

Refer to condenser user manual for condenser installation.

## 3.6 Piping For Air-Cooled Unit

Four kinds of pipes need to be installed: Condensate drain pipe of indoor unit, water inlet pipe of humidifier, copper pipes between indoor unit and condenser (air cooled series) and extension kit (optional). When installing pipes, user shall decide whether to use extension kit according to the conditions for selecting the kit.



Note

- All joints of the cooling pipes must be silver-brazed.

### 3.6.1 Pipe Extension Kit (Optional)

#### Conditions for selecting extension kit

If the one-way equivalent length exceeds 30m, or if the vertical distance between indoor unit and condenser exceeds the values in Table 3-6, consult Emerson before installation to confirm whether a pipe extension kit is needed. The pipe sizes recommended are 'equivalent lengths', with the resistance caused by bends taken into account. See Table 3-5 for equivalent lengths of partial components, and the installer should confirm that the sizes are appropriate for the site conditions.

Table 3-5 Equivalent lengths of partial components

Outer Diameter (OD) of liquid pipe (inch)	Equivalent length (m)		
	90° bend	45° bend	T type three-way
3/8	0.21	0.10	0.76
1/2	0.24	0.12	0.76
5/8	0.27	0.15	0.76
3/4	0.3	0.18	0.76
7/8	0.44	0.24	1.1
1-1/8	0.56	0.3	1.4

Table 3-6 Vertical distance between indoor unit and condenser

Relative position	Altitude difference
Condenser higher than indoor unit	20m
Condenser lower than indoor unit	5m



Note

- A trap should be installed for every 7.5m of vertical distance. Please consult Emerson for details.

### 3.6.2 Connecting condensate drain pipe of indoor unit

The condensate of infrared humidifier and evaporator is converged by a cross connector and drained through the drain pipe, as shown in Figure 3-9. The pipe OD is 25mm. If the drain pipe is used by three or more units, the minimal pipe OD should be 40mm. For the unit that uses electrode humidifier, the inner diameter of drain pipe is 40mm.



Note

- When connecting the drain pipe, you must make sure that the U bend is installed vertically and the 'U' shape is not distorted, so as to ensure that the condensate can be drained immediately and effectively.

**! warning**

- Because the infrared humidifier contains flowing hot water, the water pipe must be resistant to heat higher than 90°C. For the unit that uses electrode humidifier, the drain pipe of the condensate water must be able to withstand 120°C.

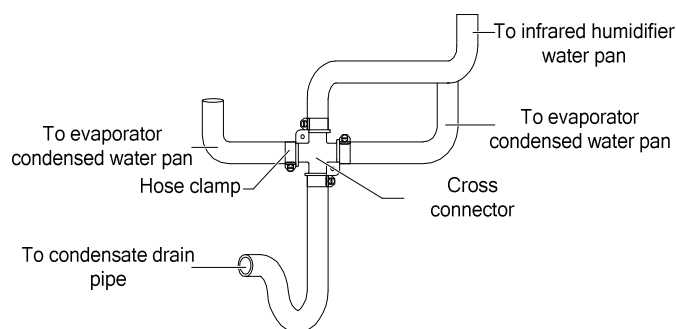

Figure 3-9 Connection of drain pipe of condensate water

### 3.6.3 Connecting water inlet pipe of humidifier

#### Connecting water inlet pipe of infrared humidifier

Requirements for connecting the water inlet pipe of infrared humidifier:

1. To facilitate maintenance, an isolation valve should be fitted to the water inlet pipe.
2. Make sure that the connection of the water inlet pipe is well sealed to prevent leakage. The infrared humidifier reserves a copper pipe (OD: 6.35mm), as shown in Figure 3-10. There is a 1/4" copper nut at the end of the copper pipe, and the 1/4" × 1/2" conversion copper thread connector has been connected to the copper nut to avoid losing them. You can also select other connection methods.

**Note**

1. Where the main pipe pressure may rise above 700kPa (The main pipe pressure should be between 100kPa ~ 700kPa), a pressure reducer should be fitted.
2. Where the main pipe pressure falls below 100kPa, a water tank and pump system should be used.
3. Some product may include components required by local codes.

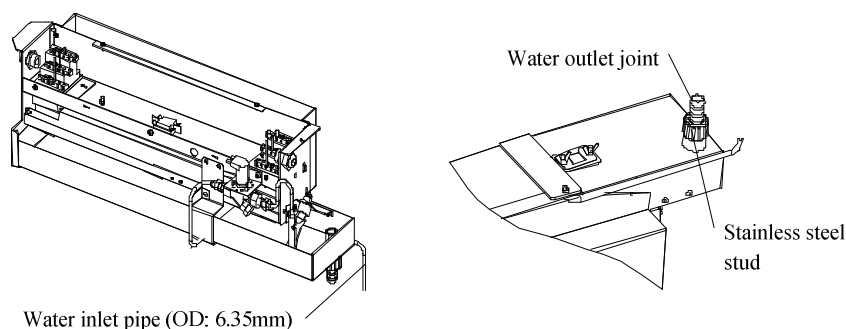

Figure 3-10 Water inlet pipe of infrared humidifier

#### Connecting the pipes of electrode humidifier (for the unit that uses electrode humidifier)

Requirements for connecting water inlet pipe of electrode humidifier:

1. Water inlet pipe uses 3/4" G screw-threaded connection pipe.
2. Water filter and water quality detection are recommended to prevent the water quality from affecting the normal operation of humidifier.

### 3.6.4 Connecting copper pipes (discharge pipe and liquid pipe) between indoor unit and condenser

1. Select the size of connection pipes of the indoor unit. Considering the effect of the pipe diameter on the system pressure drop, the pipe diameter of the indoor unit and outdoor unit should be determined according to the specifications listed in Table 3-7, or consult the technicians in local Emerson office.

2. Connect the copper pipes in welding mode. The connection ball valves of the discharge pipe and liquid pipe of indoor unit are shown in Figure 3-11. Many notes and instruction labels are pasted onto the base and side panel close to the ball valve. Note that the ball valve must be wrapped with a wet cloth before welding to protect the label from burned during the welding operation.
3. Connect the discharge pipe and liquid pipe of indoor unit according to the instructions on the label.
4. Horizontal sections of the discharge pipe should be sloped downward from the compressor, with a slope of at least 1:200 (5mm down for each 1m run). The discharge pipes should be insulated where they are routed in the conditioned space (including under a raised floor).

**⚠ warning**

- The exposure time of system pipes do not exceed 15min. Longer exposure will lead to the compressor refrigeration oil being affected with moisture, which can affect the life of the key components and the system operation stability.

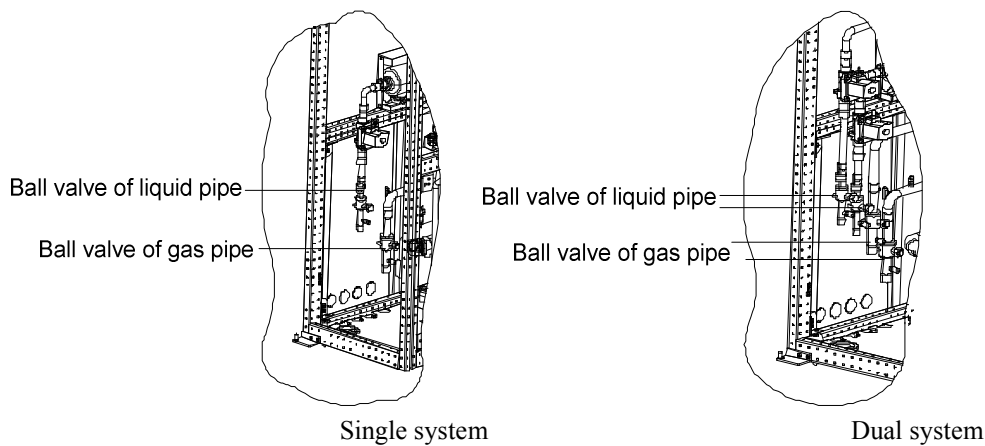

Figure 3-11 Locations of discharge pipe and ball valve in liquid pipe

Table 3-7 Recommended pipe sizes

Recommended pipe sizes (unit: mm)												
Model	P1030 (single system)		P1035 (dual system)		P1035 (single system)		P1040 (dual system)		P1045 (single system)		P1050 (single system)	
	D	L	D	L	D	L	D	L	D	L	D	L
Pipe length												
10m	22	16	22	13	22	16	22	13	22	16	22	16
20m	22	16	22	13	22	16	22	13	25	16	25	16
30m	25	16	22	13	25	16	22	16	25	19	25	19
40m*	25	16	22	16	25	16	22	16	28	19	28	19
50m*	25	19	22	16	28	19	22	16	28	19	28	19
60m*	25	19	22	16	28	19	22	16	32	19	32	19
Model	P1050 (dual system)		P2060 (dual system)		P2070 (dual system)		P3080/P1040 (single system)		P3090 (dual system)		P3100 (dual system)	
	D	L	D	L	D	L	D	L	D	L	D	L
Pipe length												
10m	22	13	22	16	22	16	22	16	22	16	22	16
20m	22	13	22	16	22	16	22	16	25	16	25	16
30m	22	16	25	16	25	16	25	16	25	19	25	19
40m*	22	16	25	16	25	19	25	19	28	19	28	19
50m*	22	16	25	19	28	19	28	19	28	19	28	19
60m*	22	16	25	19	28	19	28	19	32	19	32	19

Note:  
1. Extension kit should be added to the "Eq.Lgth" marked with \*.



## Recommended pipe sizes (unit: mm)

- |   |
|---|
| <p>2. D: discharge line, L: liquid line.</p> <p>3. Consult Emerson if the line length exceeds 60m.</p> <p>4. If the outdoor temperature of the unit is below-15°C, the low temperature kit shall be used, and please consult Emerson for details.</p> |
|---|

### 3.6.5 Installing pipe extension kit (optional, for site installation)

When the equivalent length of the one-way pipe exceeds 30m, the pipe extension kit should be installed. During the installation of the pipe extension kit, to avoid the pipe opening, it is recommended to install the solenoid valve of the pipe extension kit onto the outside project pipe of the ball valve on the liquid pipe. The outer side or the bottom of the unit is allowable. So, during installing the solenoid valve, you do not need to cut the indoor unit pipes. After the whole system is installed, you can open the ball valve to keep pressure and carry out the vacuum operation, avoiding the moisture absorption of the compressor refrigeration oil and ensuring the operation safety and life of the compressor. For the installation position of the check valve, refer to Figure 3-1. For the electrical connections of the pipe extension kit, refer to 4.2.4 (*suitable for field installation*).

## 3.7 Lowering Fan (For Down Flow Unit)

### ⚠ warning

- Be careful when lowering the fan, avoid trapping your fingers and fan cables.
- Avoid foreign matter falling into the inlet ring of the fan.

You must lower all EC fans of the downflow unit before commissioning. The downflow unit has been equipped with a lowering tool when it is shipped. The lowering tool that uses winch is shown in Figure 3-12. It mainly includes a hand winch, a winch bracket, a hook, a sling, and a handle, and also an L shaped lifting component in Figure 3-13.

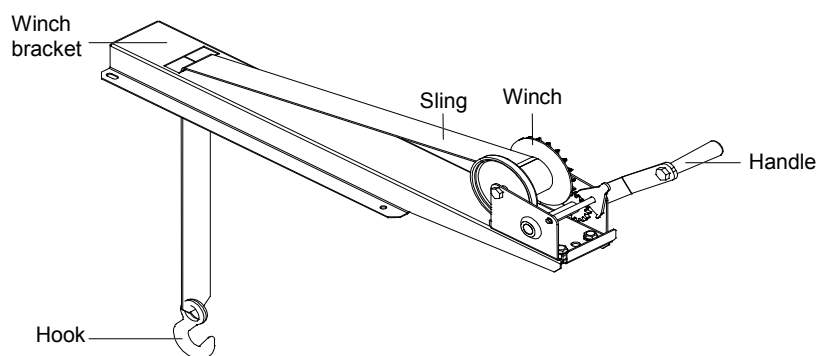

Figure 3-12 Fan elevator assembly (winch mode)

Lowering procedures:

1. Install lift and lowering kit for fan: Open the unit maintenance cover, check the fixing bolts and washers II (see Figure 3-13, totally 2 PCS) of the L shaped lifting component to make sure that it is fixed properly, and then install the fixing bolts and washers IV (totally 4 PCS) of the winch bracket, as shown in Figure 3-13;

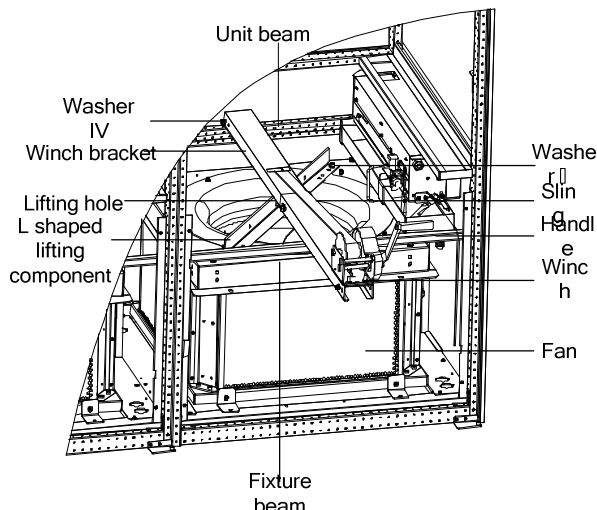

Figure 3-13 Installing winch bracket

2. Turn the handle and use the hook of the winch to hook the middle round hole (see Figure 3-13) of the L shaped lifting component. Adjust the handle until the sling is completely tight.
3. Cut off the cable tie binding the fan cables to make the cables length satisfy fan lowering requirements, and then remove the fixing bolts and washers I (see Figure 3-14, totally 4 pcs) for fan transportation.

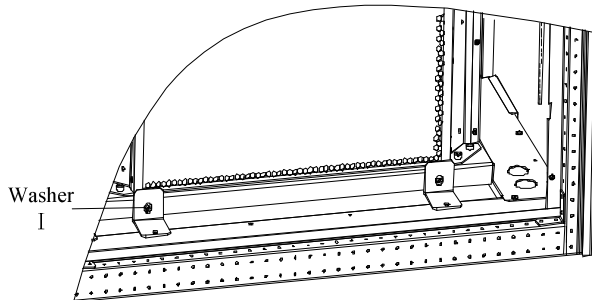

Figure 3-14 Position of fixing bolt and washer I

4. Hold the handle of the winch firmly, and then turn the handle counter-clockwise to lower the fan. After the fan is sunk, the status is shown in Figure 3-15;

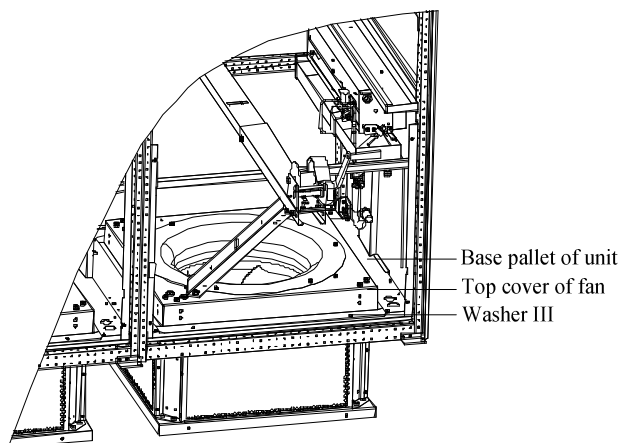

Figure 3-15 Lowered fan

5. Install the fixing bolts and washers III (see Figure 3-15, totally 4 PCS) of the fan.
6. Remove the hook from the L shaped lifting component, turn the handle clockwise, tidy the sling and remove the fixing bolts and washers IV (see Figure 3-13, totally 4 PCS) of the winch bracket, and take out the winch and the bracket assembly.
7. Remove the fixing bolts and washers II (see Figure 3-13, totally 2 PCS) of the L shaped lifting component, and take out the L shaped lifting component.

At this point, the operation of lowering the fan of one-bay unit is completed.

For the two-bay unit and three-bay unit, you should also lower other fans using the fan elevator assembly. The requirements are as follows:

1. Repeat the step 1 to step 7 of the one-bay unit to lower all fans.
2. After lowering all fans, tidy the fan cables and fix them using a cable tie.
3. Confirm if the EC fan has been lowered and installed, and ensure the blade will not touch the fan housing when the fan is rotating.

### 3.8 Removing Fastener And Vibration Absorber

To protect partial components from damaging and distorting due to bumping, impact and resonation in transportation, fasteners and vibration absorbers are mounted at certain locations before delivery. Remove the fasteners and vibration absorbers before installation and commissioning.

#### Removing transportation fixing plate of compressor

To reduce the compressor operation vibration and noise, the vibration absorbing cushions are added to the compressor base. However, such method cannot best restrain the vibration during transportation, and may result in loosened connections and wearing of certain parts. To prevent this, three L shaped fixing plates are added to the three compressor bases during transportation, as shown in Figure 3-16. After the installation and before the commissioning, remove the three L shaped fixing plates before commissioning, and then restore the bolts and washers in the sequence that is reverse to the disassembly process. The fastening torque of the bolts is  $(12\pm 1)\text{N}\cdot\text{m}$ .

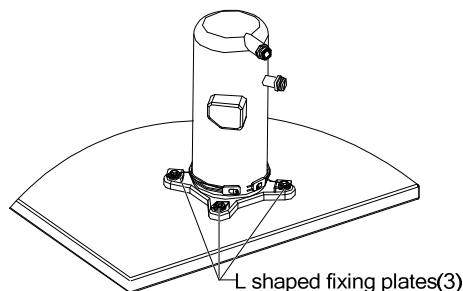

Figure 3-16 Positions of L shaped fixing plates

#### Removing fastener of infrared humidifier

The floating pole of the humidifier high water-level switch are tightly bound together with a rubber string before delivery, as shown in Figure 3-17. Remove the rubber string before unit operation. Otherwise, the unit cannot detect the high water-level alarm.

#### ⚠ warning

- Do not touch the lamps with bare fingers.

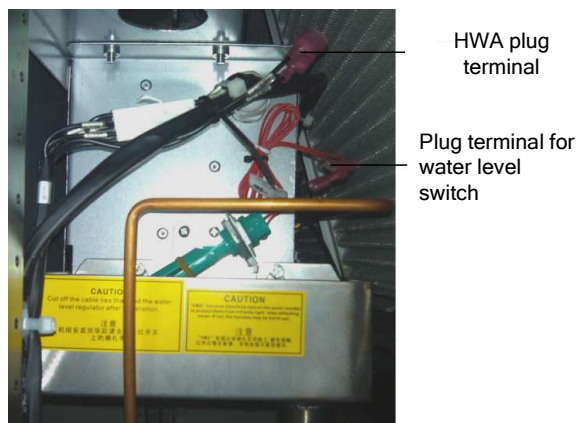

Figure 3-17 Floating pole of high water-level switch

### Removing pipe fasteners

To prevent the long copper pipes from scratching the metal plate and being damaged, the pipes are cushioned with foam or bound up before delivery. Remove those materials before power-on commissioning.

## 3.9 Installation Inspection

After the mechanical installation is completed, you should check and confirm it according to Table 3-8.

*Table 3-8 Installation Inspection*

Items	Results
Sufficient space is left around the unit for maintenance	
The equipment is installed vertically and the installation fasteners have been fixed	
The pipes between the indoor unit and outdoor unit have been connected, and the ball valves of the indoor unit and outdoor unit have been opened completely	
The condensate pump (if needed) has been installed	
The drain pipe has been connected	
The water supply pipe for the infrared humidifier has been connected	
All pipe joints have been made fixed	
The transportation fasteners have been removed	
Irrelevant things (such as transportation material, structure material and tools) inside or around the equipment have been cleared after the equipment is installed	
The air distribution system is installed as per room design (for example, raised floor/grilles, ductwork, etc)	
The upflow unit must have plenum or have air supply pipe connection, and the fan and heater shall not be accessible after installation.	

After confirming the preceding points, you can start the electrical installation.

## Chapter 4 Electrical Installation

Start electrical installation after mechanical installation is done. This chapter introduces the electrical installation of the Liebert.PEX+ AC, including installation notes, and the wiring of indoor unit, and condenser power cables.

### 4.1 Installation Notes

1. The connection of all power cables, control cables and ground cables should comply with the local and national electrician regulations.
2. The electrical installation and maintenance must be performed by authorized professional installation personnel.
3. See the unit nameplate for the full load current. The cable sizes should meet the local wiring rules.
4. Mains supply requirement: 380Vac (-10% to +15%), 50Hz, 3N~
5. If the soft power cable uses Y-connection, and if the cable is damaged, it must be replaced by professional service personnel.
6. Before the wiring, use a voltmeter to measure the power supply voltage and make sure that the power supply has been switched off.
7. The applicable grid for this air conditioner: TN, TT star connection power system; consult Emerson for other connections.
8. A breaking device shall be provided to be disconnected from power supply.

### 4.2 Wiring Of Indoor Unit

#### 4.2.1 Locating Electrical Ports Of Indoor Unit

The locations of the low voltage devices are visible after the front door of the electrical control box of the indoor unit is opened, as shown in Figure 4-1. The distribution information of the detailed low voltage components shall be differentiated according to the labels.

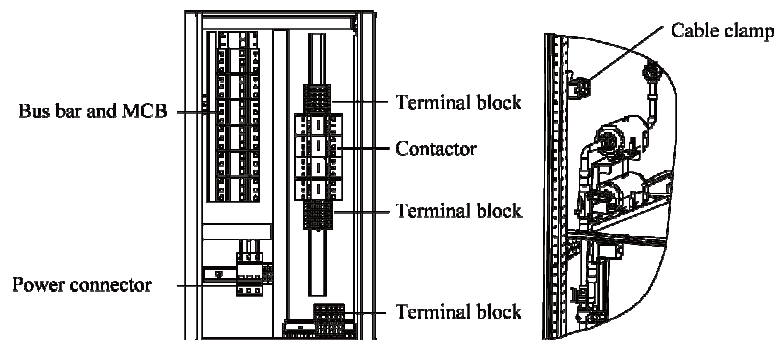

Figure 4-1 Electrical control box

#### 4.2.2 Connecting Power Cable Of Indoor Unit

The power connectors are located as shown in Figure 4-1. The enlarged view of power connector is as shown in Figure 4-2, connect terminals L1 ~ L3, N, and PE respectively to their counterparts of external power supply. Reserve some redundancy of the incoming cable and fix the cable to the cable clamp located on the inner side panel of the unit, see Figure 4-1. For the cable specification, see the rated full load ampere (FLA) listed in Table 4-1.

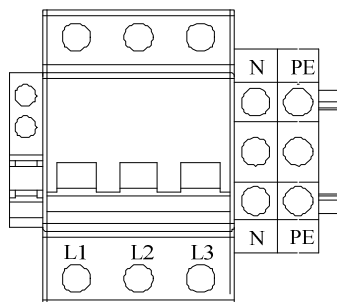

Figure 4-2 Enlarged view of power connector

**Note**

- The cable sizes should meet the local wiring regulations.

Table 4-1 Rated full load ampere (FLA) (unit: A)

Model	Standard model	With heating			No heating	
		Standard model with 2-level electric heating	1-level electric heating/ No humidifying	2-level electric heating/ No humidifying	Humidifying	No humidifying
P1020	28	37.1	28	37.1	25	18.9
P1025	33.2	42.3	33.2	42.3	30.2	24.1
P1030	32.8	41.9	32.8	41.9	29.8	23.7
P1035	35.7	44.8	35.7	44.8	32.7	26.6
P1040	43.2	56.8	43.2	56.8	35.6	29.5
P1045	48.2	61.8	48.2	61.8	40.6	34.5
P1050	51.0	64.6	51.0	64.6	43.4	37.3
P2060	61.0	74.7	61.0	74.7	58.8	47.4
P2070	66.8	80.5	66.8	80.5	64.6	53.2
P3080	77.2	95.4	77.2	95.4	70.4	59.0
P3090	82.2	100.4	82.2	100.4	75.4	64.0
P3100	87.2	105.4	87.2	105.4	80.4	69.0

Note:

- The standard model is configured with humidifier and 1-level electric heating.
- Air-cooled unit FLA excludes the condenser current .

### 4.2.3 Connecting Control Cables

The position of field connection terminals is shown in Figure 4-1, and the amplified figure is shown in Figure 4-3. The upper part of the terminal block is connected to the unit, while the lower part serves as user control signal interfaces.

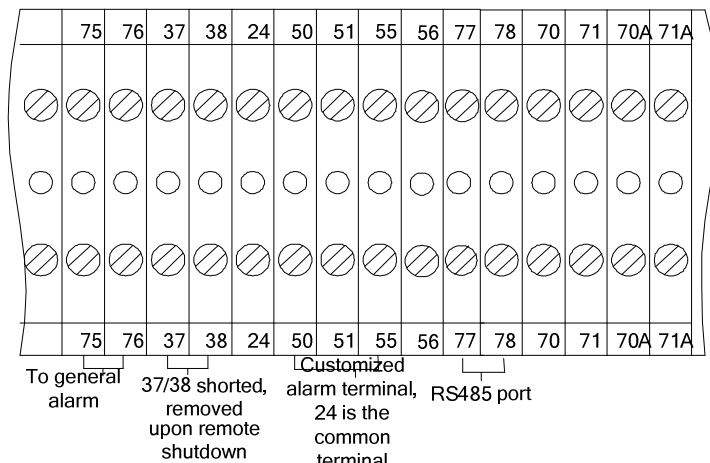



Figure 4-3 Enlarged view of terminal block

 **warning**

- The connection personnel must take anti-static measures before connecting the control cables.

### Connecting water-under-floor sensor

Each unit is equipped with a water-under-floor sensor. You should connect one end of the sensor to terminal 51#, and the other end to the common terminal 24#.

The number of the sensors in parallel connection is not limited, but each unit has only one water-under-floor alarm.

### Remote shutdown

As shown in Figure 4-3, 37# and 38# terminals can connect to remote shutdown switch, and they have been shorted in factory and the shorting cable should be removed if the terminals are to be connected to the remote shutdown switch.

 **Note**

- When 37# and 38# are opened, the unit will be shut down.

### Customized alarm terminal

Terminals 50#, 51# and 55# can be connected to three kinds of sensors, and terminal 24# is their common terminal, and can be defined as smoke sensor and water-under-floor sensor. After the customer terminals are connected with external alarm signals, you should set the corresponding customized alarm through the PACC controller, refer to 5.8.2 .

When the contact is open and no external alarm is generated, the input state of the customer terminal is open. But when the contact is closed and the external alarm is generated, the input state of the customer terminal will be shorted. At this point, the air conditioner system will generate an audible alarm, and the PACC controller LCD will display the alarm information.

Terminals 50# and 24#: Smoke detector alarm switch.

Terminals 37# and 38#: Remote alarm

Terminals 51# and 24#: Water-under-floor sensor by factory setting

### External general alarm

Terminals 75# and 76# can be connected to the external general alarms. They output signals to external alarm devices, such as alarm indicator. When critical alarm occurs, the contact will be closed to trigger remote alarms, send signals to the building management system or dial the paging system automatically. The power supply of the external general alarm system is user-prepared.

For the detailed definition of other terminals, refer to *Appendix 1*

## 4.2.4 Connecting Solenoid Valve Of Pipe Extension Kit (Options, For Site Installation)

The solenoid valve of the pipe extension kit has two control cables used to connect with the corresponding terminals of the control board. The solenoid valve cables of 1# system and 2# system in dual system unit should be remarked separately to avoid wrong connection. For specific wiring terminals in interface board, refer to the circuit diagram printed on the unit label.

 **Note**

- The controller uses the 24VAC solenoid valve port, if other types of solenoid valves are used, please consult Emerson.

## 4.3 Wiring Of Condenser

### 4.3.1 Connecting Control Signal Terminals

70#/71# and 70A#/71A# are control signal input terminals for two circuits of condensers and their switching status are identical with those of the compressor.

### 4.3.2 Connecting Control Signal Cables

Open the sealed panel of the electric control box of condenser to reveal the fan speed controller board, according to the cable connection instructions in *Liebert.PEX Condenser User Manual*. The signal cable connection of condenser is as follows:

**Wiring of a condenser with single system used to match an indoor unit with single system**

The digital signal of dry contact J6 on the board (see 3.1 *Cable terminals* in *Liebert PEX Condenser User Manual* for the locations) is connected with the control terminals 70#/71# (see Figure 4-3) of the indoor unit.

**Wiring of two condensers with single system used to match an indoor unit with dual system**

The digital signals of dry contacts J6 on the condenser board corresponding to compressor 1# are connected with the control terminals 70#/71# of the indoor unit, and the digital signals of dry contacts J6 on the condenser board corresponding to compressor 2# are connected with the control terminals 70A#/71A# of the indoor unit.

**Wiring of a condenser with dual system used to match an indoor unit with dual system**

You should short the terminals 70# & 70A# and 71# & 71A#. The digital signal of dry contact J6 on the board can be connected with the control terminals 70#/71# or 70A#/71A#. For the detailed connection, refer to *Appendix 1 Circuit Diagram*.

**Connecting Power Cables Of Condenser**

The power cables of the outdoor unit are connected with the MCBs reserved in the condenser (see Figure 4-1).

## 4.4 Installation Inspection

After the electrical installation is completed, you should confirm it according to Table 4-2.

Table 4-2 Installation Inspection

Items	Results
The power supply voltage meets the rated voltage on the unit nameplate	
The system electric loop has no open circuit or short circuit	
Power cables and ground cables to the MCBs, indoor unit and condenser are well connected	
The ratings of the MCBs and fuses are correct	
The control cables are well connected	
All the cables connections are fastened, with no loose screws	

After confirming the above points, you can start the commissioning. The commissioning is a professional operation and please contact Emerson engineer to do this job.

 **warning**

- Do not power on the unit until Emerson authorized technical has checked and confirmed the unit.



## Chapter 5 Controller Operation Instructions

Liebert.PEX+ AC uses PACC controller (“controller” for short hereafter), which has simple user interface and easy to operate menu structure. This chapter describes the appearance, control key, indicators, control interface and menus of the controller.

### 5.1 Appearance

The controller is shown in Figure 5-1. The display board uses 240 X 128 dot-matrix blue backlight LCD that can display words and drawings clearly.

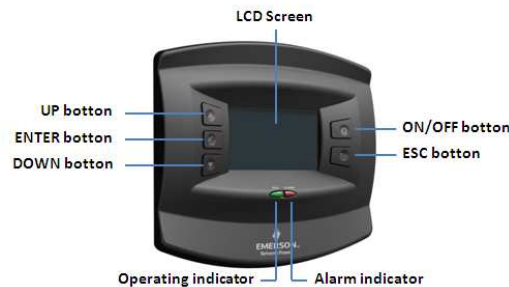

Figure 5-1 Appearance of controller

### 5.2 Control Keys

The controller provides five controls keys (see Figure 5-1), including ON/OFF, ESC, UP, DOWN and ENTER keys. Their detailed functions are listed in Table 5-1.

Table 5-1 Function description of keys

Key	Function description
ON/OFF key	Switch on/off the controller.
ESC key	<ol style="list-style-type: none"> <li>1) Press this key to quit the current menu and enter the previous menu.</li> <li>2) When changing a parameter, pressing this key can abolish the current parameter change.</li> <li>3) Holding the key can enter the help menu, which will detail values, such as max., min., default and a brief description of the data fields.</li> <li>4) When an alarm is generated, pressing the key can mute the audio alarm.</li> </ol>
Up key	<ol style="list-style-type: none"> <li>1) Press this key to move up the cursor or increase the value of the displayed parameter during parameter setting.</li> <li>2) If the input data field is a toggle selection, pressing the key can scroll through the available options.</li> <li>3) When a menu is displayed on several screens, pressing the key can scroll up.</li> </ol>
Enter key	Press this key to enter the next menu, or save the setting after parameters are changed.
Down key	<ol style="list-style-type: none"> <li>1) Press this key to move down the cursor or decrease the value of the displayed parameter during parameter setting.</li> <li>2) If the menu is a toggle selection, pressing the key can scroll through the available options.</li> <li>3) When a menu is displayed on several screens, pressing the key can scroll down.</li> </ol>
ENTER key + UP key	<ol style="list-style-type: none"> <li>1) It is a key combination. Press the ENTER key, then UP key, release the UP key, then ENTER key to complete a key operation.</li> <li>2) The key combination is used to view the state of previous air conditioner.</li> </ol>
ENTER key + DOWN key	<ol style="list-style-type: none"> <li>1) It is a key combination. Press the ENTER key, then DOWN key, release the DOWN key, then ENTER key to complete a key operation.</li> <li>2) The key combination is used to view the state of next air conditioner.</li> </ol>

### 5.3 Indicators

The controller provides two indicators: operation indicator and alarm indicator, as shown in Figure 5-1. The functions are described in Table 5-2.

Table 5-2 Description of indicator functions

Indicator	Color	Status	Functions
Operation indicator	Green	On	Controller works normally.
		Off	Controller works normally.
Alarm indicator	Red	On	No alarm happens.
		Flash	Alarm happens.

## 5.4 Control Interface

The LCD screen displays the communication state after the controller is powered on. If the controller can not communicate with its target interface board, the LCD screen will prompt **Communication Failure**. If the communication is normal, the screen will display shutdown interface or main interface, which depends on whether the air conditioner is on or off. The control interface includes main interface, shutdown interface and password interface.

### 5.4.1 Main Interface

If the air conditioner is powered on, after successful communication, the main interface will appear, as shown in Figure 5-2. If no control key is pressed within 10min, the controller will enter a screen-saving state (the back lighting is off) until any control key is pressed. In main interface, press **Enter** to enter main menu.

The main interface provides the following information: date, time, week day, display board and interface board addresses, actual temperature, temperature set point, actual humidity, humidity set point, unit working icons (including fan, cooling, humidifying, dehumidifying, heating, general alarm, locking and on/off/standby state).

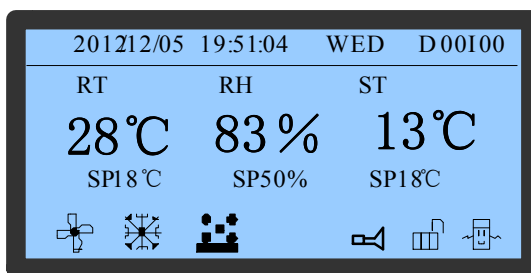

Figure 5-2 Main interface

#### Unit working icons

The main interface provides three modes of unit working icons: dynamic running state icons, locking state icons and on/off/standby state icons. These icons inform the operators of the operation mode in which the air conditioner is working. The icons and their definitions are listed in Table 5-3.

Table 5-3 Icon definitions

Mode	Icon	Definition	Mode	Icon	Definition
Dynamic running state icons		Fan running	Locking state icons		Locking state
		Cooling			Unlocking state
		Heating state	On/off/standby state icons		Standby state
		Humidifying			Shut-down state
		Dehumidifying			Running state
		General alarm	/	/	/

### 5.4.2 Shutdown Interface

If the air conditioner unit is in shutdown status, the controller will enter shutdown interface after communication is successful, as shown in Figure 5-3. The displayed shutdown interface is dependent on the shutdown mode of the air conditioner unit.

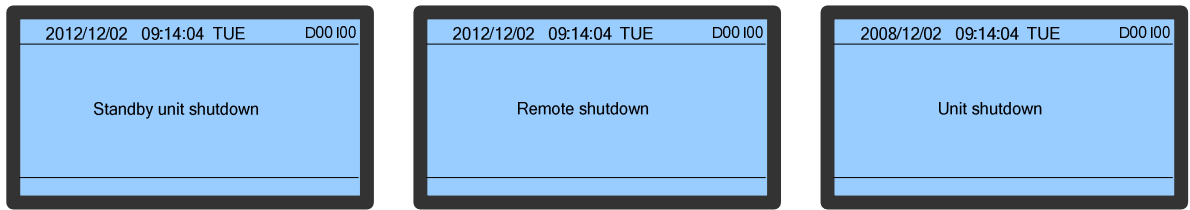

Figure 5-3 Shutdown interface

### 5.4.3 Password Interface

Press the ENTER key under the main interface or shutdown interface to enter the password interface as shown in Figure 5-4. Three levels of passwords are provided for accessing the menu interface. After entering the different levels of passwords, you can operate the corresponding menus, and see Table 5-4 for user, initial password and the access level for menus of each password level, where user can operate the menus that require Level 1 Password, and Emerson technicians can operate the menus that require Level 2 & 3 Passwords. The access level for any menu item is indicated by a number enclosed in brackets at the end of each menu, such as [1], [2] and [3].

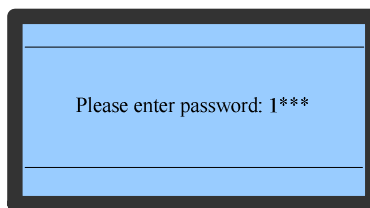



Figure 5-4 Password interface

Table 5-4 Password level

Password level	User	Initial password
Level 1	General operator	0001
Level 2	Emerson technicians	****
Level 3	Emerson technicians	****

 Note

- The menus that require Level 2 & 3 Passwords are operated by Emerson technicians;
- If password is wrongly entered, press ESC to return and make modifications.

## 5.5 Main Menu

The controller menus are constructed in a tree-like structure, as shown in Appendix 2 Menu Structure of PACC Controller (Standard Configuration).

After user starts up the unit, in the **Main Interface**, press **Enter** to enter **Password Interface**, then enter the main menu and each submenu to query, set or modify the parameters.

Enter the main menu interface, and operate according to the following procedures:

1. Press the ENTER key to enter the password interface;
2. Press the ENTER key to highlight the input data field in the password interface;
3. Press the UP or DOWN key to change the current number;
4. Press the Enter key to confirm the password and enter the Main Menu interface.

## 5.6 Submenu

1. The Main Menu includes 10 sub-menus and is displayed on two screens, as shown in Figure 5-5.
2. The menus are classified into user menus and professional maintenance menus according to different password protection levels. User menus are described in 5.7 *User Menu* and professional maintenance menus are described in 5.8 *Professional Maintenance Menus*.

- Press **Up** and **Down** in **Main Menu** to select submenus and press **Enter** to enter the maintenance level submenu.

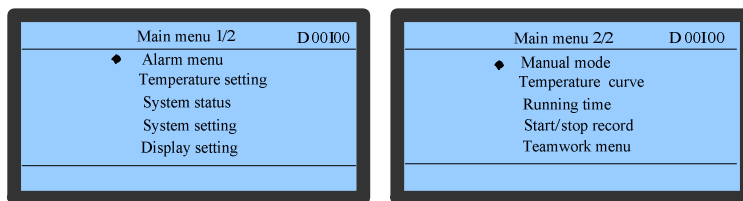

Figure 5-5 Main menu



Note

- The menu with black dot displayed on left means this menu has submenu or the parameter of this menu is settable.

### Setting parameters of submenus

Press **Up** or **Down** to move the cursor to the submenu to be selected, when the cursor is in the selected menu, a black dot is displayed on the left side of the menu. At this time, press **Enter** to enter the submenu or set the parameters of this menu. The menu is classified into the menu with settable parameter or the menu with non-settable parameter. The parameter setting operation is as follows with high temperature alarm control menu as an example:

- Press **Up** or **Down** in **Main Interface** to move cursor to **Alarm Menu**.
- Press **Enter** to enter the **Alarm Menu** interface.
- Press **Up** or **Down** in **Alarm Menu** to move cursor to **Alarm Control Menu**.
- Press **Enter** to enter **Alarm Control Menu**.
- Press **Up** or **Down** in **Alarm Control Menu** to move cursor to **High TEMP Alarm**.
- Press **Enter** to highlight parameter bit of **High TEMP Alarm**.
- Press **Up** or **Down** to select parameter.
- After selecting parameter, press **Enter** to confirm and validate the parameter.
- Press **ESC** to back to the higher level menu interface.



Note

- After changing the parameter, if you do not press **Enter** to confirm, **High TEMP Alarm** will keep the original parameter value.

## 5.7 User Menu

### 5.7.1 User Menu Introduction

User menu are the menus for user to query or set parameters. The user menu function is described in Table 5-5.

Table 5-5 User menu function

User sub-menu function	Path	User sub-menu function
Alarm menu→Alarm status	Main menu→Alarm menu	Query current alarm status
Alarm menu→Alarm setting	Main menu→Alarm menu	Set alarm values
Alarm menu→Alarm history	Main menu→Alarm menu	Query history alarm records
TEMP/HUM setting	Main menu	Query and set TEMP/HUM parameters
Display setting	Main menu	Set the teamwork address and display contrast
TEMP/HUM curve	Main menu	Query the TEMP/HUM change trend within 6h to 48h.

### 5.7.2 Alarm Menu

Press **Up** and **Down** in **Main Menu 1/2** to move cursor to **Alarm Menu** and press **Enter** to enter the **Alarm Menu** interface. This menu has five submenus as shown in Figure 5-6.

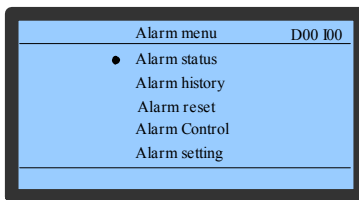

Figure 5-6 Alarm menu

**Alarm status**

This menu is used to record all active alarm statuses, including **Active Alarms** (total alarm number), **ALM** (alarm SN. and alarm type), and **Time** (alarm start time and end time), as shown in Figure 5-7. The controller can store up to 100 alarm status records.

Note

- The alarm status records will be cleared automatically upon power failure.

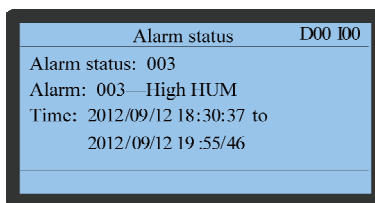

Figure 5-7 Alarm status

**Alarm set point**

The alarm set point menu is shown in Figure 5-8. The settings of the **Alarm Set Point** menu will not be lost upon power failure. For detailed setting ranges of menu items, refer to *Appendix 3 Alarm Control Menu Table*.

Note

- It is recommended not to change the defaults of the alarm set points. If necessary, operate under the guidance of trained professionals.

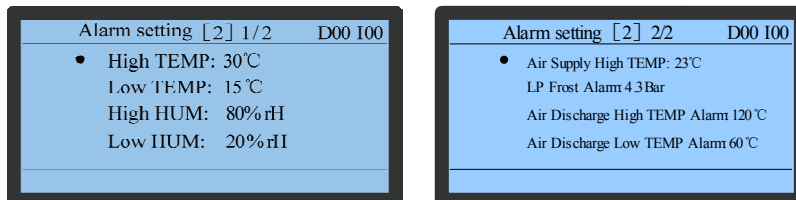

Figure 5-8 Alarm set point interface

**Alarm history**

This alarm interface is used to query the history alarm records, including **Active Alarms** (total alarm number), **ALM** (alarm SN. and alarm type), and **Time** (alarm start time and end time) as shown in Figure 5-9.

Note

- When several alarms are generated, the alarm with biggest alarm SN is the latest alarm, and you can press the UP or DOWN key to scroll through the alarms. The controller can store up to 200 history alarm records. They will not be cleared upon power failure.

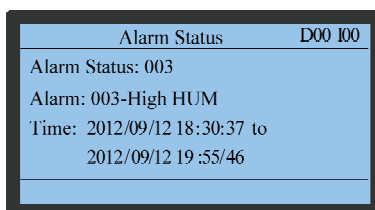

Figure 5-9 Alarm history

### 5.7.3 Set Point Control

Press **Up** and **Down** in **Main Menu 1/2** to move cursor to **Set Point Control** and press **Enter** to enter the **Set Point Control** interface, as shown in Figure 5-10.

The set points will not be lost upon power failure. The menu is used to set the temperature & humidity on which the air conditioner is working and their sensitivities.

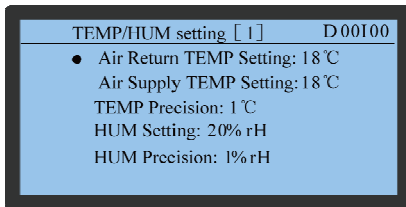

Figure 5-10 Set point control interface

### 5.7.4 Display Setting

Press **Up** and **Down** in **Main Menu 1/2** to move cursor to **Display Setting** and press **Enter** to enter the display setting submenu, as shown in Figure 5-11.

The display setting can set the CAN communication address of display board in team work mode.

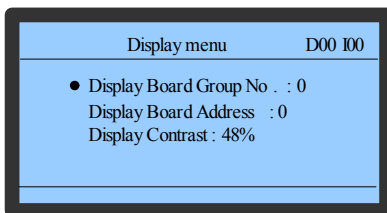

Figure 5-11 Display setting

### 5.7.5 Graph Menu

Press **Up** and **Down** in **Main Menu 2/2** to move cursor to **Graph Menu** and press **Enter** to enter the **Graph Menu**, as shown in Figure 5-12. Through the menu, you can browse the temperature and humidity graphs, which reflect the temperature and humidity changes over a period of time in the past.

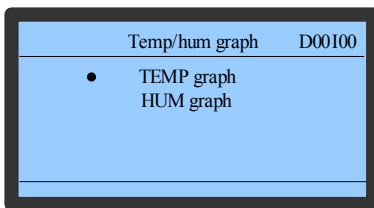

Figure 5-12 Graph menu

1. Select **Graph Menu -> TEMP** to enter the **TEMP** submenu, as shown in Figure 5-13.

In the graph, current temperature is the origin, time is the horizontal axis and temperature is the vertical axis. The graph displays the temperature changes from 6h to 48h through zooming operation and controlling cursor movement. Press the UP or DOWN key to move the cursor to the required zoom-control bar. Press the ENTER key to enter editing status and then press the UP or DOWN key to zoom the graph in or out.

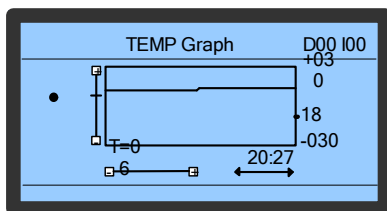

Figure 5-13 Temperature graph interface

2. Select **Graph Menu** -> **HUM** to enter the **HUM** submenu, as shown in Figure 5-14.

In the graph, current humidity is the origin, time is the horizontal axis and humidity is the vertical axis. The graph displays the humidity changes from 6h to 48h through zooming operation and controlling cursor movement. Press the UP or DOWN key to move the cursor to the required zoom-control bar. Press the ENTER key to enter editing status and then press the UP or DOWN key to zoom the graph in or out.

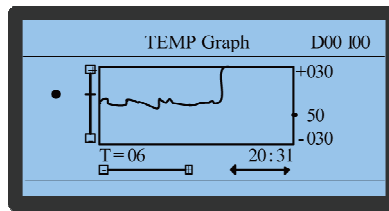

Figure 5-14 Air humidity graph interface

## 5.8 Professional Maintenance Menus

### 5.8.1 Professional Maintenance Menus Introduction

The professional maintenance menus are used to guide maintenance personnel to query the running status; set running parameters and trouble shoot the unit. The submenus and functions are described in Table 5-6.

Table 5-6 Functions of professional maintenance menus

User submenu	Path	User submenu function
Alarm menu→Alarm reset	Main menu→Alarm menu	Clear some important alarm status
Alarm menu→Alarm control	Main menu→Alarm menu	Query and set all the alarm controls
System status	Main menu	Query the output status, input status and power status of components, and set the customer input parameters.
System setting	Main menu	Set the parameters of unit and select running mode.
Manual mode	Main menu	Manually control the operation of each component.
Run hours	Main menu	Query the component run hours or reset run over time.
Start/stop records	Main menu	Query the start/stop records of some important components (such as fan, compressor, humidifer and electric heater)
Teamwork menu	Main menu	When multiple units are used together, query or set team work control mode, unit number, standby unit number, overlap function, rotation number, manual rotation, rotation period and rotation time, and query the status of #00 to #32 units.

### 5.8.2 Alarm Menu

#### Alarm reset

Alarm reset menu is as shown in Figure 5-15. This interface is used to clear some important alarm status. The menu items can be set to **YES** or **NO**, and the default is "No". If **Reset Compressor 1 HP Alarm** is set to **YES**, after a **Compressor 1 HP Alarm** is generated, its corresponding record on the **Alarm Status** menu will be cleared.

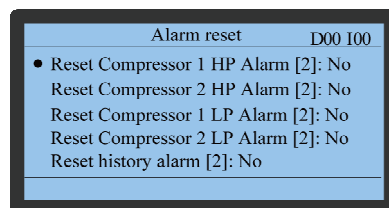

Figure 5-15 Alarm reset

**Alarm control**

The settings of the **Alarm Control** menu will not be lost upon power failure. You can browse and set all alarm control items. For **Alarm Control** submenus, refer to Appendix 2 Menu Structure of PACC Controller (Standard Configuration). The **Alarm Control** menu is displayed on 12 screens. Press the **UP** or **DOWN** key to select the required submenu. Taking the first screen as an example, the interface is shown in Figure 5-16.

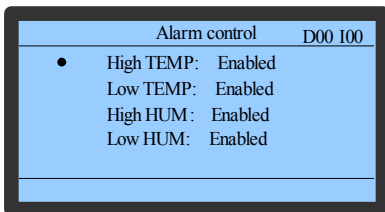

Figure 5-16 Alarm control

The menu items (excluding **Customer Input**) can be set to **On**, **Event** or **Off**.

- **On**: when an alarm is generated, the Alarm Status menu will pop up with a buzzer beeping and general alarm output. You also can find records in the Alarm Status and Alarm History menu.
- **Event**: when an alarm is generated, there are alarm status and alarm history records without any prompt.
- **Off**: when an alarm is generated, no record or prompt will appear.

The tenth screen is the Customer Input menu, and is used to set alarm control type and input polarity. Select and enter the submenu of Customer Input Menu, as shown in Figure 5-17. The Alarm Control items can be set to **On**, **Event** or **Off**, and the logic meaning is the same as other alarm control. The Input Polarity item can be set to **Open** or **Closed**.

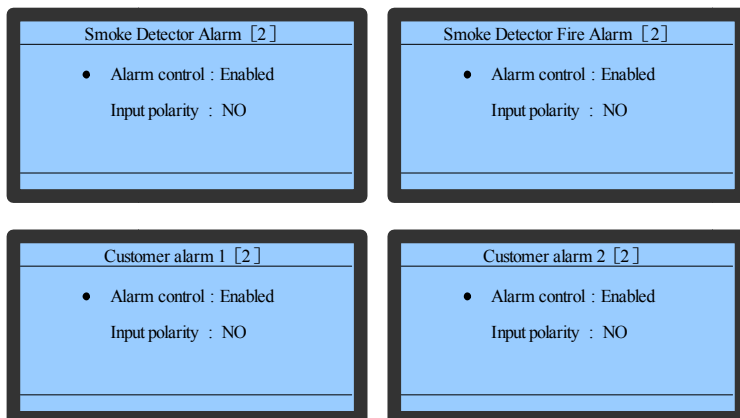

Figure 5-17 Customer input interface

**5.8.3 System Status**

Select **Main Menu 1/2 -> System Status** to enter the **System Status** menu, as shown in Figure 5-18. You can browse the input status, output status, and power status of the air conditioner components or set the Customer Input Status items.

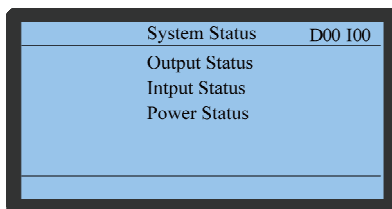

Figure 5-18 System status

**Output status**

The **Output Status** menu is as shown in Figure 5-19.



Output Status 3/3:	D00 I00
Liquid BP Valve 1: On	
Liquid BP Valve 2: On	
SCR Out 1: Off	
SCR Out 2: Off	

Output Status 1/3:	D00 I00
Fan: On	Fill: Off
Dehumidify: On	HUM: Off
Cooling 1: On	Cooling 2: On
Heat 1: On	Heat 2: Off
HGBP: Off	General alarm: On

Output Status 2/3:	D00 I00
Analog Output 1: 0.0V	
Analog Output 2: 0.0V	
Analog Output 3: 10.0V	

Figure 5-19 Output status interfaces

### Input status

The **Input Status** menus are displayed on five screens. Press the UP or DOWN key to select the required menu item. Taking the first screen as an example, the interface appears as shown in Figure 5-20. For detailed menus, refer to Appendix 2 Menu Structure of PACC Controller (Standard Configuration).

Input status 1/5	D00 I00
HP Switch 1:	Closed
HP Switch 2:	Closed
LP Switch 1:	Open
LP Switch 2:	Open
Coil Frost Switch 1:	Open
Coil Frost Switch 2:	Open

Figure 5-20 Input status interface

For the heating resistor temperature, air supply / coil temperature, water circuit / air discharge 2 temperatures, and water circuit / air discharge 1 temperature in fifth screen, user can enter the self-defined status. Each sub-menu interface is shown in Figure 5-21.

Heating Resistor TEMP
Detected TEMP : 21 °C
• TEMP Caliber : 00°C

Air supply /coil TEMP
Detected TEMP : 21 °C
• TEMP Caliber : 00°C

Water circuit/air discharge 1 TEMP
Detected TEMP : 21 °C
• TEMP Caliber : 00°C

Water circuit/air discharge 2 TEMP
Detected TEMP : 21 °C
• TEMP Caliber : 00°C

Figure 5-21 NTC input

### Power status

The **Power Status** menu is as shown in Figure 5-22. You can browse the input power statuses of the air conditioner: A-Phase Voltage, B-Phase Voltage, C-Phase Voltage and Power Frequency.

Power status	D00 I00
A Phase volt	: 219V
B Phase volt	: 220V
C Phase volt	: 220V
Power frequency	: 50.0Hz

Figure 5-22 Power status

## 5.8.4 System Menu

Press **Up** and **Down** in **Main Menu 1/2** to move cursor to **System Menu** and press **Enter** to enter the **System Menu**. The menu is displayed in two screens, as shown in Figure 5-23.

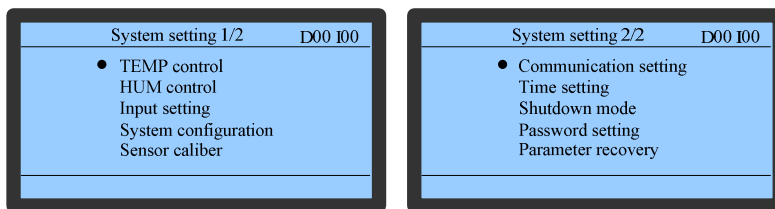

Figure 5-23 System menu

**TEMP Control**

The **TEMP Control** menu is displayed on two screens, as shown in Figure 5-24. Only Emerson technicians can access the latter seven menu items.

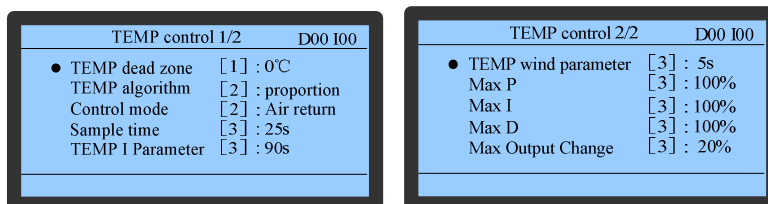

Figure 5-24 TEMP control

**HUM control**

The **HUM Control** menu is displayed on two screens, as shown in Figure 5-25. Only Emerson technicians can access this menu.

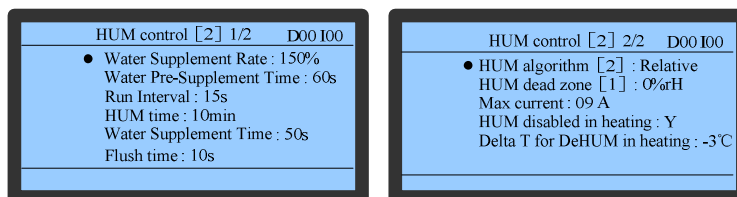

Figure 5-25 HUM control

**Input setup**

The **Input Setup** menu is as shown in Figure 5-26. Only Emerson technicians can access this menu.

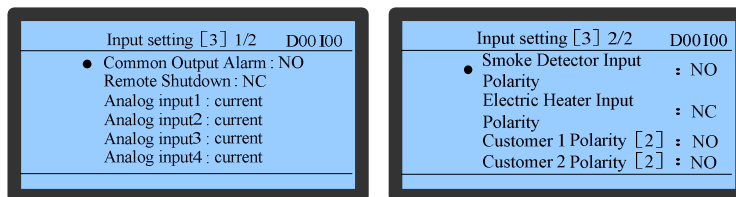

Figure 5-26 Input setup

**System config**

The **System Config** menu is as shown in Figure 5-27, including option menus, delay setting, air flow detection, water circuit setting and EC fan control.

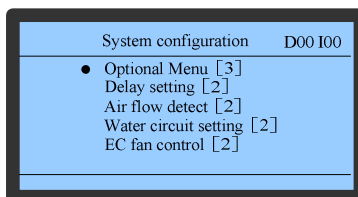

Figure 5-27 System config

**1. Option menu**

The option menu is shown in Figure 5-28. Only Emerson technicians can access this menu.

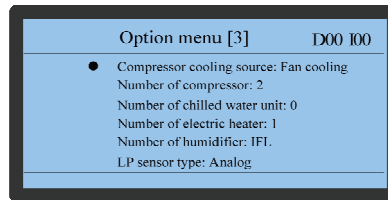

Figure 5-28 Option menu

## 2. Delay config

The delay config is displayed in two screens, as shown in Figure 5-29.

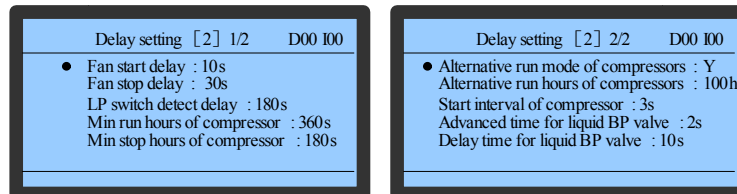

Figure 5-29 Delay config

## 3. Air flow detection

The air flow detection menu is shown in Figure 5-30.

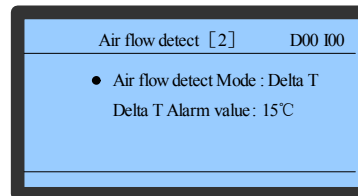

Figure 5-30 Air flow detection

## 4. Water circuit setting

The water circuit setting menu is shown in Figure 5-31.

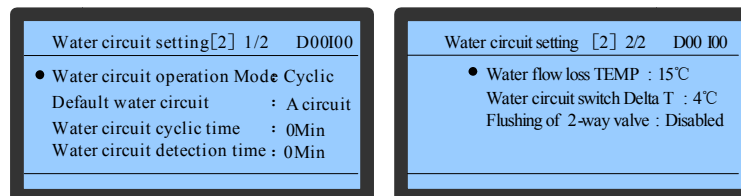

Figure 5-31 Water circuit setting

## 5. EC fan control

EC fan control menu is shown in **Figure 5-32**.

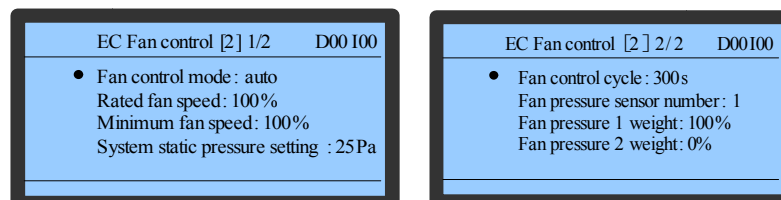

Figure 5-32 EC fan control

## Sensor calibration

The **Sensor Calibration** menu is as shown in Figure 5-33.

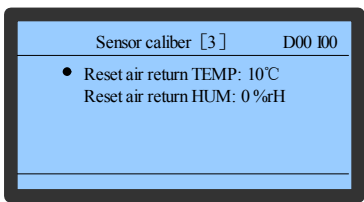

Figure 5-33 Sensor calibration

**Communication**

The **Communication** menu is as shown in Figure 5-34.

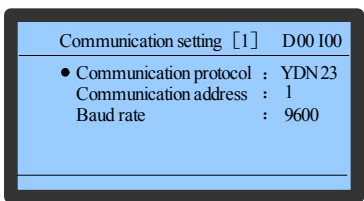

Figure 5-34 Communication interface

**Set Time/Date**

The **Set Time/Data** interface is as shown in Figure 5-35.

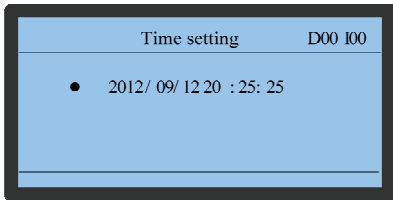

Figure 5-35 Time setting

**Shutdown mode**

The shutdown mode menu is as shown in Figure 5-36.

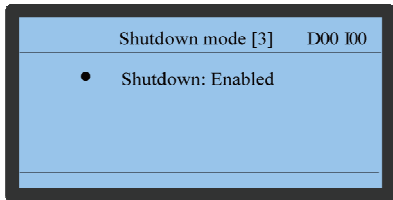

Figure 5-36 Shutdown mode

**Password protection**

The password protection menu is as shown in Figure 5-37.

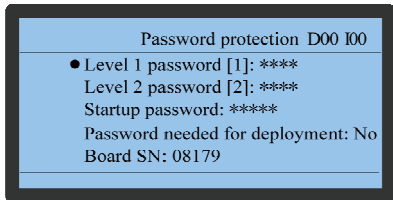

Figure 5-37 Password protection

**Parameter reset**

The **Parameter Reset** interface is as shown in Figure 5-38.

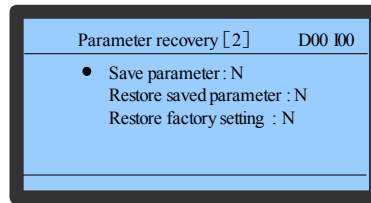

Figure 5-38 Parameter reset

### 5.8.5 Run Hours

Press **Up** and **Down** in **Main Menu 2/2** to move cursor to **Run Hours** and press **Enter** to enter the **Run Hours**, as shown in Figure 5-39. User can browse the total run hours of fan, compressor, heater and humidifier, and set operation **Service Interval**.

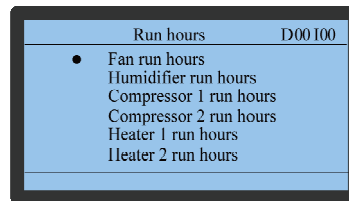

Figure 5-39 Run hours

The "run hours" submenus of fan, compressor, heater and humidifier are the same, taking fan run hours as an example, the submenu interface is shown in Figure 5-40. In this menu, user can view the total run hours of the fan. If the hours in **Run Hours** of fan exceed that in **Service Interval**, the system will generate an alarm to inform the maintenance personnel of fan maintenance. After the fan is maintained, the **Run Hours** will be cleared. After setting the **Hour Reset** to **YES**, the maintenance personnel can reset the **Service Interval**.

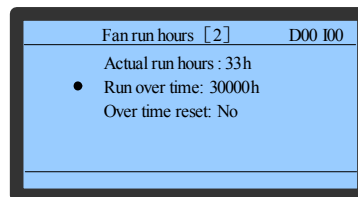

Figure 5-40 Run hours interface

### 5.8.6 On/Off Record

Press **Up** and **Down** in Main Menu 2/2 to move cursor to **On/Off Record** and press **Enter** to enter the **On/Off Record**, as shown in Figure 5-41. Only Emerson technicians can access the menu.

This menu is used to record the on/off information of some important components, such as fan, compressor, heater and humidifier. These records provide a base and reference to maintenance personnel.

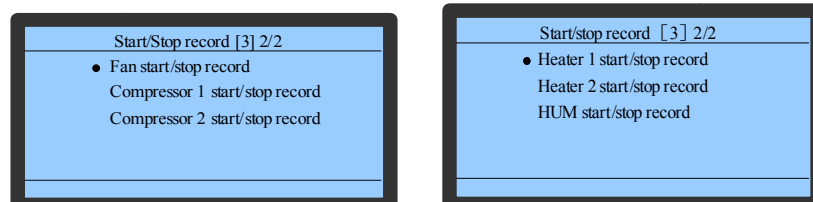

Figure 5-41 On/Off Record

The submenus of fan, compressor, heater and humidifier are the same. Taking the Fan On/Off Record menu as an example, as shown in Figure 5-42. The menu items include on/off records (total record number), No. (Record SN) and time (fan on and off time).

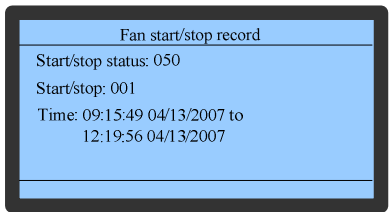

Figure 5-42 Fan on/off record

### 5.8.7 Manual Mode

Press **Up** and **Down** in **Main Menu 2/2** to move cursor to **Manual Mode** and press **Enter** to enter the **Manual Mode**, as shown in Figure 5-43.

The controller will enter manual mode when “Manual” setting is set to “enabled”. In this mode, you can set whether other parts will run and the running status. Set “Manual” to “Off”, the controller will exit manual mode and enter auto mode. In manual mode, after the controller restarts, the controller will restore to auto mode.

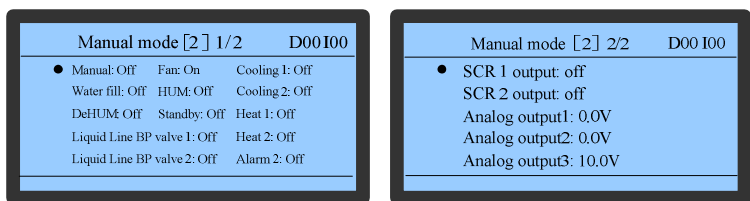

Figure 5-43 Manual mode

### 5.8.8 Team Work

Press **Up** and **Down** in **Main Menu 2/2** to move cursor to **Team Work** and press **Enter** to enter the **Team Work**. The menu is displayed on 3 screens, as shown in Figure 5-44. The second screen shows the operating status of #00~#31 units. The team work mode can be set to single, mode 0, mode 1, mode 2 or mode 3, which are applicable to different cases:

- Single: Each air conditioner operates independently without communication with others.
- Mode 0: All air conditioners operate independently. But communication exists among them.
- Mode 1: It is applicable to the case with an even temperature & humidity load.
- Mode 2: It is applicable to the case with an uneven temperature & humidity load. Each air conditioner independently distributes the requirement.
- Mode 3: It is applicable to the case with an uneven temperature & humidity load. The lead air conditioner distributes the requirement.

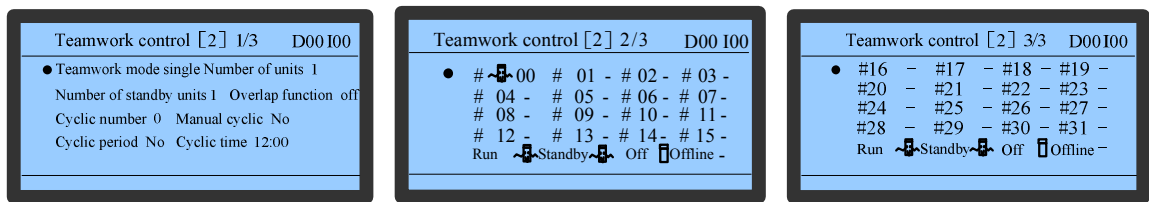

Figure 5-44 Team work interface

## Chapter 6 System Operation And Maintenance

This chapter introduces the operation and maintenance of the Liebert.PEX+ AC, including routine maintenance and inspection items, electrical connection inspection, control component appearance checking, and air cooled condenser, filter , infrared humidifier and electric heating maintenance guidance.

### warning

- During the operation of the Liebert.PEX+ , lethal voltage may be present in theequipment.It is a must to obey all the notes and warnings marked on the equipment or contained in this manual, otherwise injury or fatality may occur.
- Only qualified maintenance personnel can operate and handle the equipment.

### 6.1 Monthly Routine Inspection Items

Check the system components monthly, focusing on system function and component wearing symptoms, and the inspection items are shown in Table 6-1.

Table 6-1 Monthly routine inspection items

Components	Inspection items	
Filter	Check if filter is clogged and damaged.	
	Clean the filter	
Fan	Check if fan blades are distorted.	
Compressor	No leakage	
	Check for noise and observe vibration condition	
Air cooled condenser	Cleanliness of condenser fins	
	Fan base is rigid.	
	Check if vibration absorbing cushion is aging or damaged	
	Check if SPD board(if any) is working, and check once a week in thunderstorm seasons.	
	Refrigerant pipes have suitable support	
Cooling system	Check refrigerant pipes	
	Check the moisture condition in system through sight glass	
	Check HGBP valve (if HGBO system is equipped)	
	Check thermal expansion valve	
	Check water inlet/outlet temperature for unit with dual cooling sources or free cooling unit	
	Check if the condensed water pan is clogged	
Heating system	Check the operation of reheat system components	
	Check eroding condition of components	
Infrared humidifier	Check if water pan drainage is clogged	
	Check the lamp of humidifier	
	Check water pan for mineral deposits	

### 6.2 Routine Inspection Items (Half A Year)

See Table 6-2 for the routine maintenance items every half a year.

Table 6-2 Routine maintenance items every half a year

Components	Inspection items	
Filter	Check if filter is clogged and damaged	
	Clean the filter	
Fan	Check if fan blades are distorted.	
	Bearings in good condition	
	Check and fix connectors	

Components	Inspection items	
Compressor	No leakage	
	Check for noise and observe vibration condition	
	Check and fix connectors	
Air cooled condenser	Cleanliness of condenser fins	
	Fan base is rigid.	
	Check if vibration absorbing cushion is aging or damaged	
	Check if SPD board(if any) is working, and check once a week in thunderstorm seasons.	
	Refrigerant pipes have suitable support	
	Check and fix connectors	
Water cooled condenser	Clean pipe system	
	Check the function of ball valve	
	Check if the water system leaks	
Cooling system	Check the refrigerant pipes that must have support bracket and should not be closed to wall, floor or fixed frames with vibrations.	
	Check the moisture condition in system through sight glass	
	Check HGBP valve	
	Check thermal expansion valve	
	Check if the system needs to be added with refrigerants through sight glass	
Heating syste	Check the operation of reheat system components	
	Check and fix connectors	
Infrared humidifier	Check if water pan drainage is clogged	
	Check the lamp of humidifier	
	Check water pan for mineral deposits	
	Check and fix connectors	
Electric control part	Check and fix connectors	

### 6.3 Self-diagnosis Function

The PACC controller features a diagnostic function that enables you to turn on/off the components in site manually so as to check their functionality.

### 6.4 Electrical Connection Inspection

The inspection items include:

1. Conduct overall electrical insulation test: find out the unqualified contacts and handle them. Note to disconnect the fuses or MCBs of the control part during the test lest the high voltage should damage the control components.
2. Check the contactors before power-on and make sure the contactors can act freely without obstruction.
3. Clean the electric and control elements of dust with brush or dry compressed air.
4. Check the closing of contactors for arcs or signs of burning. Replace the contactor if necessary.
5. Fasten all the electric connection terminals.
6. Check that the sockets and plugs are in good condition. Replace those loosened ones.
7. If the power cables are damaged, to avoid damage, the cables must be replaced by professional personnel.

### 6.5 Control Component Appearance Inspection

Carry out visual inspection and simple function test by referring to the following items:

1. Visually inspect the power transformers and isolation transformers, and test the output voltage (of the indoor unit and outdoor condenser).
2. Check that there is no signs of aging on the control interface board, control board, temperature and humidity sensor board and fuse board.
3. Clean the electric control elements and control board of dust and dirt with brush and electronic dust removing agent.
4. Check and fasten the I/O ports at the control interface board, including the connection between control board and control interface board, as well as between the temperature/humidity sensor board and the interface board.



5. Check the connection between the user terminals (70#, 71#, 70A#, 71A#, 37#, 38#) and the control interface board.
6. Check the output connection between the control interface board and various contactors and solenoid valves for liquid pipes, and the input connection between control interface board and fan overload protector, high pressure switch, heating over-temperature protection switch, humidifier protection switches, discharge air temperature sensor, and low pressure sensor. In particular, check the connection parts such as high pressure switches and solenoid valves, and replace the component if in poor connection or faulty.
7. Check and replace electrical components that are faulty, such as control fuses (or MCBs) and control boards.
8. Check the specification and aging condition of the control cable and power cable between the indoor unit and the condenser, and replace the cables when necessary.
9. Use temperature and humidity measuring meters with higher precision to measure and calibrate the temperature and humidity sensors.

 Note

- Set the humidity control mode to 'relative humidity control' during calibration process.

10. Adjust the setpoints. Check the action of the functional parts and the auto-flush control logic of water pan of the infrared humidifier according to control logic.
11. Simulate and check the operation of the protection devices including high and low pressure alarm, high and low temperature alarm, high water level alarm and over-temperature protection.
12. Check the water detection sensor.

Bridge the water detection sensor probes and confirm the alarm through the controller.

The sensor should be placed away from any water pool or drainage trench on the floor, 2m ~ 2.5m away from the unit. Do not place it directly under the unit. The recommended installation location of the water detection sensor is shown in Figure 6-1.

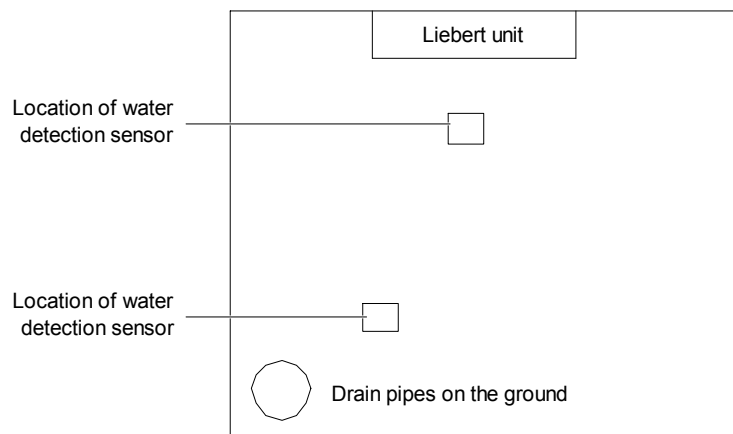



Figure 6-1 Recommended location for the water detection sensor

 warning

- Before fastening the connection of any mechanical parts or cables, make sure that the power supply of the control unit has been disconnected.
- Do not use the water detection sensor adjacent to flammable liquid or use it to detect flammable liquid.

## 6.6 Air Cooled Condenser

Refer to associated condenser user manual for details.

## 6.7 Filter

The efficiency of the filter in the unit is 30%, which complies with US ASHRAE52-76 and Eurovent 4/5 standards, and the dust resistance value is 90%(EU4 standard). To ensure the normal operation of the filter, the filter service alarm logic is provided by the controller. The default fan running time is 2000 hours, when the time is exceeded, the filter

service alarm is triggered. User needs to replace the filter based on the clogging condition of the filter. The filter must be checked once a month, and be replaced as required during operation.



#### Note

- Cut the power before replacing the filter.
- Clear the fan running time to 0 after replacing the filter.

## 6.8 Infrared Humidifier

During the normal operation of the infrared humidifier, sediment such as mineral particles will accumulate on its water pan. To ensure efficient operation of the infrared humidifier, you need to clean the sediment regularly. However, the cleansing cycle varies because the water is different in different regions. It is recommended to check, and cleanse (when necessary) the water pan, once a month. The autoflush function of the infrared humidifier can prolong the cleansing cycle. However, regular checks and maintenance are necessary.

Cleaning steps:

1. Remove the water level standpipe to drain the water pan;
2. Disconnect the drainage pipe;
3. Remove the safety switch of the water pan;
4. Remove the fixing screws at the two ends of the pan, and pull out the water pan. Cleanse the water pan with water and hard brush;
5. Restore the water pan by reversing the preceding procedures.



#### Warning

- Before exercising the corresponding operation, make sure that the power has been cut off; and also ensure that the water in the water pan is close to the room temperature before draining the water from the infrared humidifier water pan so as to avoid the personal injury.

## 6.9 Electric Heater

The electric heater is as shown in Figure 6-2. Three temperature switches are series connected to the control loop inside the electric heater, including two automatic reset switches and one manual reset switch.

1. Check the rustiness condition of the electric heater; use the iron brush to get rid of the rust, or replace it according to actual conditions.
2. When there is heating requirement, but no heating effect, you should use a multimeter to check whether the cable connected to temperature switch is in action, so as to ensure the three temperature switches are normal.
3. If the cable is not in action, you should remove the electric heater to check whether the manual reset switch is disconnected, the automatic reset switch or the electric heater pipe is damaged.

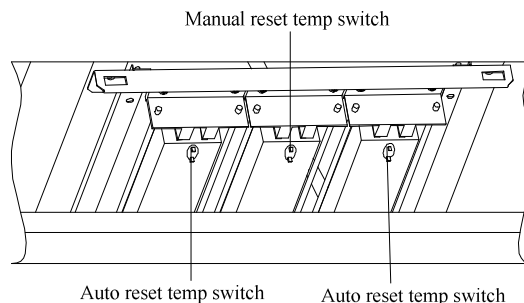

Figure 6-2 PTC electric reheat

## Chapter 7 Troubleshooting

This chapter introduces the troubleshooting of Liebert.PEX+ AC, mainly including the troubleshooting and fault handling of fan, infrared humidifier, compressor and cooling system, and heating system, and the simple troubleshooting and faults handling that can be performed by users. Please contact Emerson for complex troubleshooting and fault handling.

### warning

- Certain circuits carry lethal voltages. Only professional technicians are allowed to maintain the unit. Extra care should be taken when troubleshooting a live unit.
- If jumpers are used for troubleshooting, remember to remove the jumpers after the troubleshooting. The connected jumpers may bypass certain control function and damage the equipment.

### 7.1 Fan Troubleshooting

The fan troubleshooting is listed in Table 7-1.

Table 7-1 Fan fault removal

Symptom	Potential causes	Items to be examined or handled
ECfan cannot be started	MCB disconnection	Examine the MCB of main fan , check if the fans L1, L2 and L3 are power-off, or have phase failure or undervoltage
	Control board failure	1) Check if the green LED beside the relay K1 on the control panel is on or not to judge is the board fails 2)Check if J64 has 0~10Vdc analog output, if no, check the control board.
Air loss alarm is displayed	the filter is clogged	Check if the filter is clogged that causes low air flow, if so, replace the filter

### 7.2 Infrared Humidifier Troubleshooting

See Table 7-2 for infrared humidifier troubleshooting.

Table 7-2 Troubleshooting of infrared humidifier

Symptom	Potential causes	Items to be examined or handled
Humidification ineffective	No water in the water pan	Check that the water supply is normal
		Check that the water supply solenoid valve is working
		Check the state of the high water-level switch and water level regulator
		Check that the water supply pipe is not clogged
	The humidification contactor does not close	Check if the contactor voltage is normal
		Check if the safety devices of the infrared humidifier are opened, such as water pan over-temperature protection switch and over-temperature protection switch at top.
	Humidifier main power failure	Check that the humidifier MCB is closed; In humidifier contactor closed state, check that L1, L2 and L3 voltages are normal
Infrared humidifier lamp burned	Replace the lamp	

### 7.3 Compressor and Cooling System Troubleshooting

See Table 7-3 for troubleshooting compressor and cooling system.

Table 7-3 Troubleshooting of compressor and cooling system

Symptom	Potential causes	Items to be examined or handled
Compressor cannot start	Power is not on (shutdown)	Check if the main power switch or MCB and the connection cable are normal
	Circuit connection loosened	Fasten the connections
compressor cannot work	High pressure switch action	Check if there is a high pressure alarm with reference to chapter 5
	Check air discharge temperature sensor	Check if Low/High TEMP alarm of air discharge exists with reference to chapter 5
	Check low pressure sensor	Check if there is coil frost or low pressure alarm in history alarms with reference to chapter 5 to confirm if refrigerant leaks
	Contactor failure	Check if the contactor has 24Vac drive input
	MCB disconnected	Check the MCB and the contactor, and then measure the circuit voltage
Big noise of compressor	Liquid returned	Refer to the handling methods of <i>Low suction pressure or liquid returned</i>
	Lubricant loss	Add lubricant
	Fixture of compressor is not removed	Remove the transportation fixture
Note: The cooling and dehumidifying demand is the precondition for judging the potential causes listed in this table		

## 7.4 Heating System Troubleshooting

See Table 7-4 for troubleshooting heating system.

Table 7-4 Heating system troubleshooting

Symptom	Potential causes	Items to be examined or handled
Heating system does not operate, and the contactor does not close	Auxiliary relay failure of heater	Check if the LED besides the relay is on and if the circuit is correct
	Heating system safety equipment disconnection	Check if the manual reset switch is opened and check if the auto reset switch is damaged
Contactor closed, no heating effect	Power failure of heater	Check if the heating MCB is closed; When the heating contactor is closed, check if the L1, L2 and L3 voltages of contactor are normal
	Heater burnout	Cut off the power to check the heater

# Appendix 1 Circuit Diagram

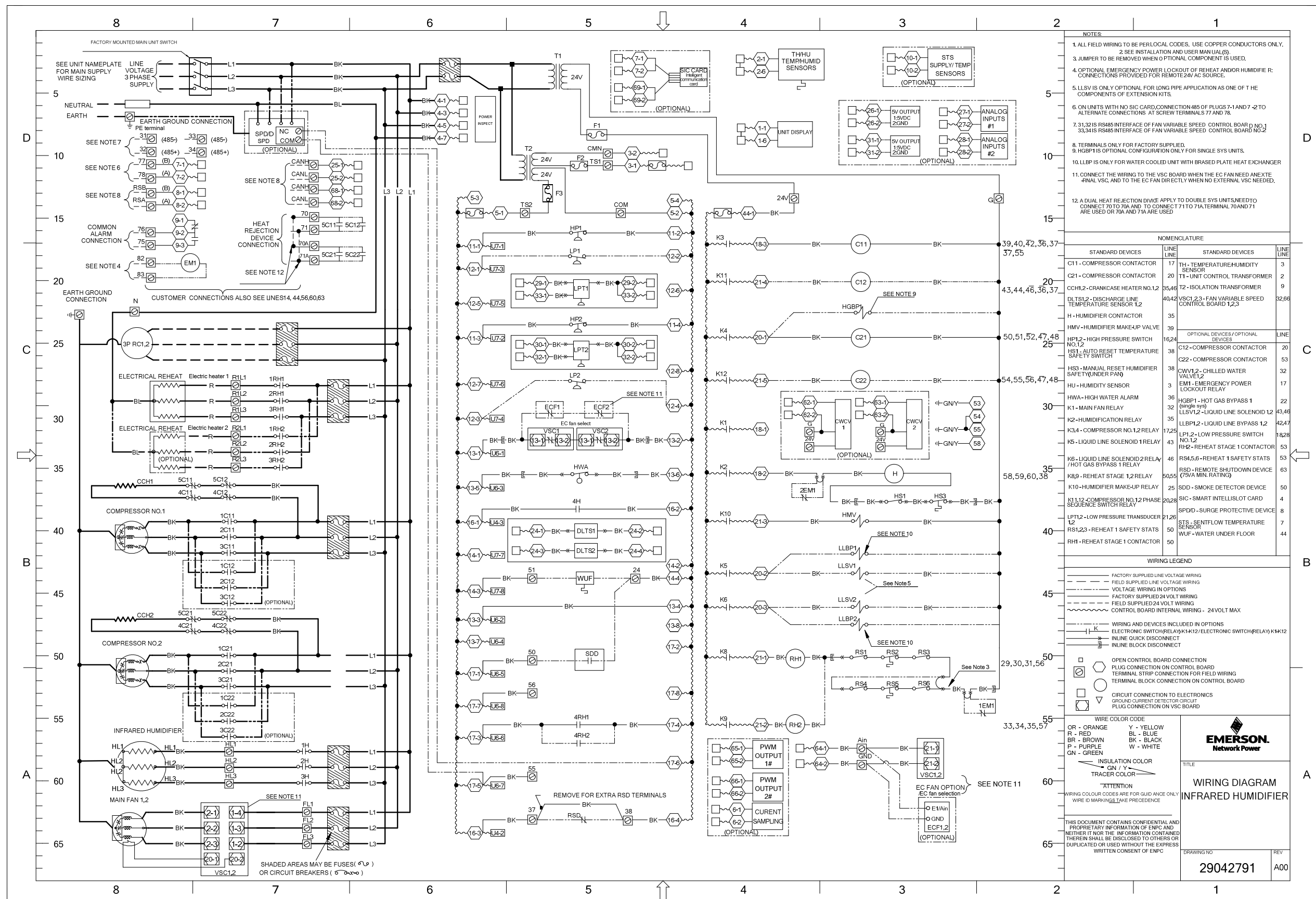



## Appendix 2 Menu Structure of PACC Controller (Standard Configuration)

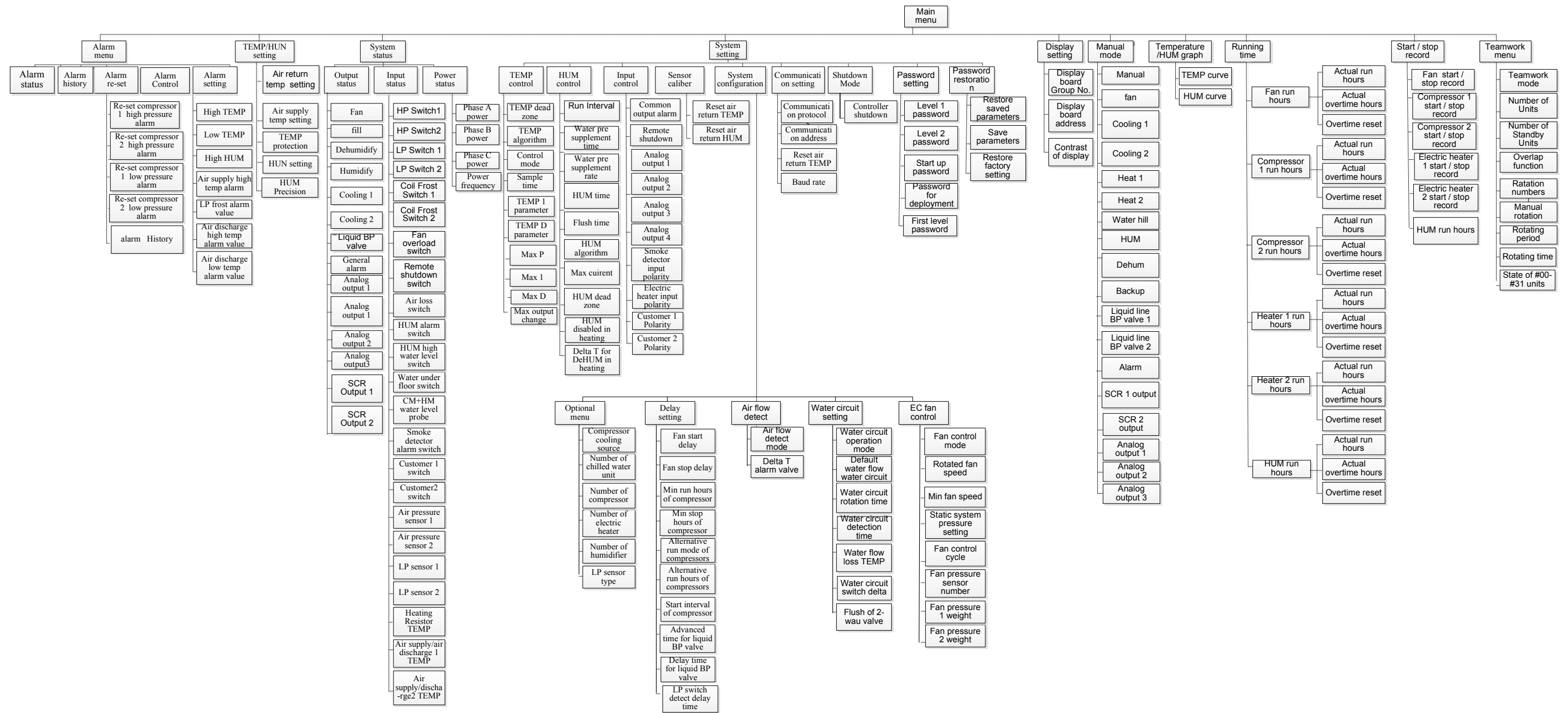





## Appendix 3 Alarm Control Menu Table

Alarm control				
High TEMP	Low TEMP	High HUM	Low HUM	
C1 HP	C2 HP	C1 LP	C2 LP	
LP Sensor 1 Alarm	LP Sensor 2 Alarm	HP1 lock	HP2 lock	
LP1 lock	LP2 lock	High temperature alarm of air discharge 1	High temperature alarm of air discharge 2	
Low temperature alarm of air discharge 1	Low temperature alarm of air discharge 2	Discharge High TEMP1 lock	Discharge High TEMP2 lock	
Discharge Low TEMP1 lock	Discharge Low TEMP2 lock	Loss of power	Over Volt	
Low Volt	Freq error	Phase loss	Phase reverse	
Remote shutdown	High TEMP of Air Supply	Fan overload	Air loss	
Water Loss A	Water Loss B	Coil1 frost lock	Coil2 frost lock	
Clogged filter	IR HUM error	HUM high water	Air Pressure Sensor Error	TEMP/HUM Detector Error
Smoke detected	Heater Fault	Customer 1 Alarm	Customer 2 Alarm	Water Detected
NTC1 Fault	NTC2 Fault	NTC3 Fault		
Repetitive Address	Slave Loss	Master Loss		
Fan hours exceeded	C1 hours exceeded	C2 hours exceeded		
Heater 1 Service Interval	Heater 2 Service Interval	HUM Service Interval		

## Appendix 4 Hazardous Substances or Elements Announcement

Parts	Hazardous Substances					
	Plumbum	Hydrargyrum	Cadmium	Chrome6+	PBB	PBDE
	Pb	Hg	Cd	Cr6+	PBB	PBDE
Cabinet	×	○	○	○	○	○
Cooling part	×	○	○	○	○	○
Fan unit	×	○	×	○	○	○
Heater unit	×	○	○	○	○	○
Electric control unit	×	○	×	○	○	○
LCD	×	×	○	○	○	○
PCBA	×	○	○	○	○	○
Heat exchanger	×	○	○	○	○	○
Copper bus	×	○	○	○	○	○
Cables	×	○	○	○	○	○
<p>○: Means the content of the hazardous substances in all the average quality materials of the part is within the limits specified in SJ/T-11363-2006;</p> <p>×: Means the content of the hazardous substances in at least one of the average quality materials of the part is outside the limits specified in SJ/T11363-2006</p>						
<p>Emerson Network Power Co., Ltd. has been committed to the design and manufacturing of environment-friendly products. It will reduce and eventually eliminate the hazardous substances in the products through unremitting efforts in research. However, limited by the current technical level, the following parts still contain hazardous substances due to the lack of reliable substitute or mature solution:</p> <ol style="list-style-type: none"> <li>1. The reason that the above parts contain plumbum: copper alloy, high temperature solders in the products and diode, glass part of resistor (exempted) and electronic ceramic (exempted) contain plumbum;</li> <li>2. Backlight bulb contains Hydrargyrum</li> <li>3. The contacts of MCB in distribution unit contain Cadmium.</li> </ol>						
<p>About Environment Protection Period: The Environment Protection Period of the product is marked on the product. Under normal working conditions and normal use of the products observing relevant safety precautions, the hazardous substances in the product will not seriously affect the environment, personnel safety or property in the Environment Protection Period starting from the manufacturing date.</p>						
<p>Applicable product: Liebert.PEX+ series precision air conditioner</p>						

## Appendix 5 Monthly Routine Inspection Items

Date: \_\_\_\_\_

Recorded by: \_\_\_\_\_

Model: \_\_\_\_\_

SN: \_\_\_\_\_

Components	Inspection items	Remark
Filter	Check if filter is clogged and damaged.	
	Clean the filter	
Fan	Check if fan blades are distorted.	
	Bearings in good condition	
Compressor	No leakage	
	Check for noise and observe vibration condition	
Air cooled condenser	Cleanliness of condenser fins	
	Fan base is rigid.	
	Check if vibration absorbing cushion is aging or damaged	
	Check if SPD board(if any) is working, and check once a week in thunderstorm seasons	
	Refrigerant pipes have suitable support	
Cooling system	Check refrigerant pipes	
	Check the moisture condition in system through sight glass	
	Check HGBP valve (if HGBO system is equipped)	
	Check thermal expansion valve	
	Check water inlet/outlet temperature for unit with dual cooling sources or free cooling unit	
Heating system	Check the operation of reheat system components	
	Check eroding condition of components	
Infrared humidifier	Check if water pan drainage is clogged	
	Check the lamp of humidifier	
	Check water pan for mineral deposits	

Signature \_\_\_\_\_

Note: Please duplicate this table for archiving.

## Appendix 6 Routine Inspection Items (Half A Year)

Date: \_\_\_\_\_

Recorded by: \_\_\_\_\_

Model: \_\_\_\_\_

SN: \_\_\_\_\_

Components	Inspection items	Remark
Filter	Check if filter is clogged and damaged	
	Clean the filter	
Fan	Check if fan blades are distorted.	
	Bearings in good condition	
	Check and fix connectors	
Compressor	No leakage	
	Check for noise and observe vibration condition	
	Check and fix connectors	
Air cooled condenser	Cleanliness of condenser fins	
	Fan base is rigid.	
	Check if vibration absorbing cushion is aging or damaged	
	Check if SPD board(if any) is working, and check once a week in thunderstorm seasons	
	Refrigerant pipes have suitable support	
	Check and fix connectors	
Water cooled condenser	Clean pipe system	
	Check the function of ball valve	
	Check if the water system leaks	
Cooling system	Check the refrigerant pipes that must have support bracket and should not be closed to wall, floor or fixed frames with	
	Check the moisture condition in system through sight glass	
	Check HGBP valve	
	Check thermal expansion valve	
	Check if the system needs to be added with refrigerants through sight glass	
Heating syste	Check the operation of reheat system components	
	Check and fix connectors	
Infrared humidifier	Check if water pan drainage is clogged	
	Check the lamp of humidifier	
	Check water pan for mineral deposits	
	Check and fix connectors	
Electric control part	Check and fix connectors	

Signature \_\_\_\_\_

Note: Please duplicate this table for archiving.